

THE BAUSCH & LOMB BALPLAN MICROSCOPE

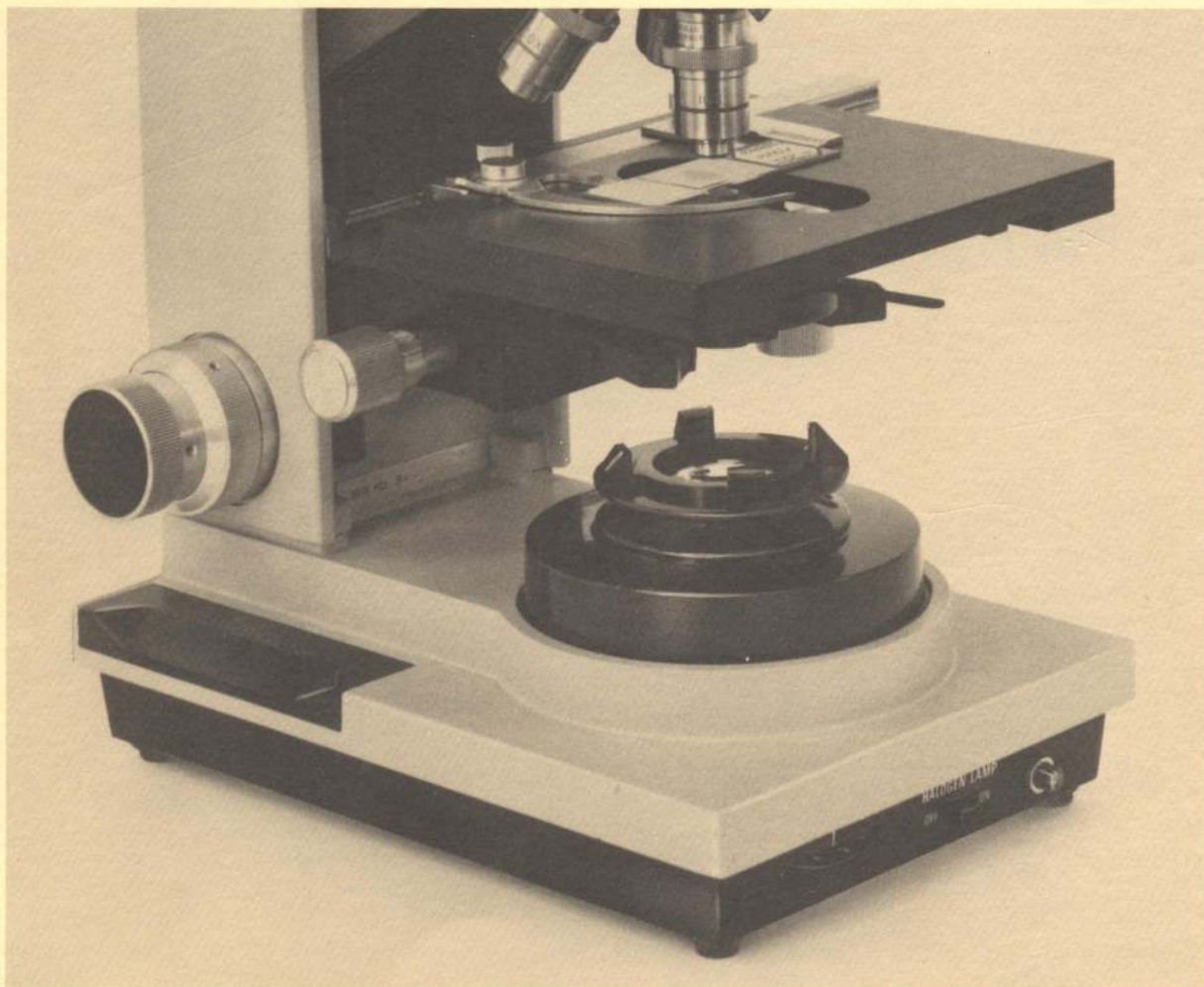

INSTRUCTION MANUAL

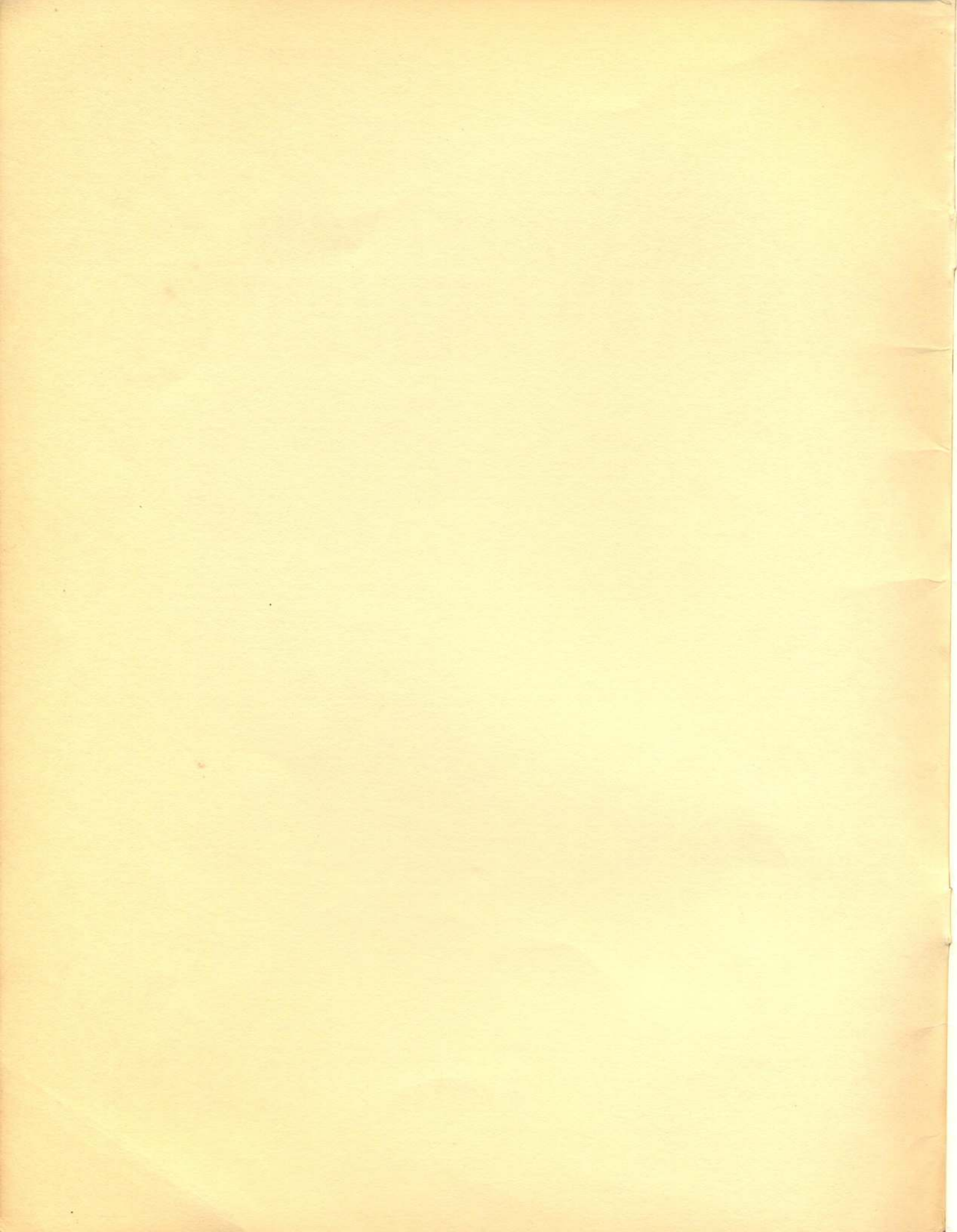

TABLE OF CONTENTS

SECTION - 0		SECTION - 9	
Service	0-1	Viewing Adapters	9-1
Service Record	0-2	SECTION - 10	
Introduction	0-3	Photomicrography	10-1
SECTION - 1		SECTION - 11	
Unpacking and Preparation For Use	1-1	Filters	11-1
SECTION - 2		SECTION - 12	
Operating Procedure	2-1	Phase Contrast Microscopy	12-1
SECTION - 3		SECTION - 13	
Head Types	3-1	Polarized Light Microscopy	13-1
SECTION - 4		SECTION - 14	
Objectives and Eyepieces	4-1	Dark Field Microscopy	14-1
SECTION - 5		SECTION - 15	
Stage Types	5-1	Measuring	15-1
SECTION - 6		SECTION - 16	
Substage Condensers	6-1	Care of the Microscope	16-1
SECTION - 7		SECTION - 17	
Illuminators	7-1	Carrying Case	17-1
SECTION - 8		SECTION - 18	
Nosepieces	8-1	List of Parts	18-1

WARRANTY

This product is warranted to be free from defects in materials or workmanship. If within one year of its purchase it is found to have any such defects, it will be repaired without charge. . . parts not of Bausch & Lomb manufacture carry the guarantee of their manufacturers.

This warranty does not cover damage in transit; damage caused by carelessness, improper servicing, modifications made by others than Bausch & Lomb Incorporated, misuse, or neglect; or unsatisfactory performance as a result of conditions beyond our control. Expendable components (i.e. lamps, fuses, etc) carry no warranty.

Should further information on your warranty be required contact your dealer.

To validate this warranty, the attached owner's reply card must be completed and returned within 15 days after purchase.

RESPONSIBILITY FOR SAFE DELIVERY

Especially designed and tested packaging is provided for all Bausch & Lomb products to protect them from normal transportation hazards and assure their safe delivery.

After the product leaves the factory, responsibility for its safe delivery is assumed by the transportation company handling the shipment.

If your shipment shows evidence of rough handling, request the party making the delivery to note "received in bad order" on your delivery receipt. If "concealed damage" is revealed after the shipment is unpacked, contact a representative of the transportation company and request that a "Bad Order" report be made out.

In either event, the transportation company should be notified immediately of any damage to your shipment to protect your rights to recovery.

IMPROVEMENTS

Improvements are constantly being made in all Bausch & Lomb products to provide better performance, greater convenience of use, longer life, and improved appearance.

Often, the nature of such improvements will be self evident and will not require an explanation.

If the improvements affect use or maintenance procedures, supplementary instructions will be included in your manual or with the instrument.

— Bausch & Lomb Incorporated

SERVICE

All optical and mechanical equipment requires periodic servicing to keep it performing properly and compensate for normal wear.

Anticipating this need by establishing a schedule of regular preventive maintenance will help to assure long life and sustained optimum performance for your instrument. It will also help to avoid unexpected trouble and the necessity of having the instrument serviced at inconvenient times.

Such a program of planned preventive maintenance, involving a thorough cleaning, checking and adjustment of mechanisms is recommended for all instruments.

This work should only be performed by qualified personnel with the proper training and equipment. Your dealer, or Bausch & Lomb, can arrange this service.

IF - unexpected trouble is experienced with your instrument

FIRST - contact your Bausch & Lomb dealer. He may be able to suggest simple remedies to correct the apparent difficulty without having to send the instrument out for servicing.

SHOULD - it become necessary to send your instrument out for service:

PLEASE - pack the instrument carefully in a crush resistant carton with at least three inches of shock absorbing material surrounding it to prevent in-transit damage. If a suitable carton is not available, one may be ordered from the factory.

INCLUDE - a detailed letter in the shipping carton, preferably fastened to the instrument, describing the trouble experienced. This information will enable the service technician to effect required repairs promptly and at least expense.

NOTE

Please mark on shipping container FIRST CLASS LETTER ENCLOSED. First Class postage will have to be paid only on the letter. The carton will be accepted at standard package rates.

SERVICE RECORD

Type of instrument _____

Model _____

Catalog number _____

Serial number* _____

Date purchased _____, 19 _____

Purchased from _____

_____ Phone _____

Date Serviced	Service Center or Technician Servicing Instrument	Preventive Maintenance Check-up (check)	Other Service Performed or Parts Replaced (describe)

*See Fig. 1-1

INTRODUCTION

The Bausch & Lomb Balplan Microscope is the most advanced instrument of its type. It embodies superior performance, flexibility, ease of operation, durability, and interchangeability. The Microscope is designed to permit the easy addition of components to allow the practice of the latest techniques in Microscopy.

The Microscope features a variety of:

Heads	Condensers
Nosepieces	Illuminators
Objectives	Attachments*
Stages	

*The following is a partial list of attachments which demonstrate the versatility of the Microscope:

- Dual Viewing Adapter
- Multiple Viewing Adapter
- Focusable Bertrand Lens
- Filter Attachment
- Analyzer
- Polarizer
- Phase Contrast Accessories
- Cameras

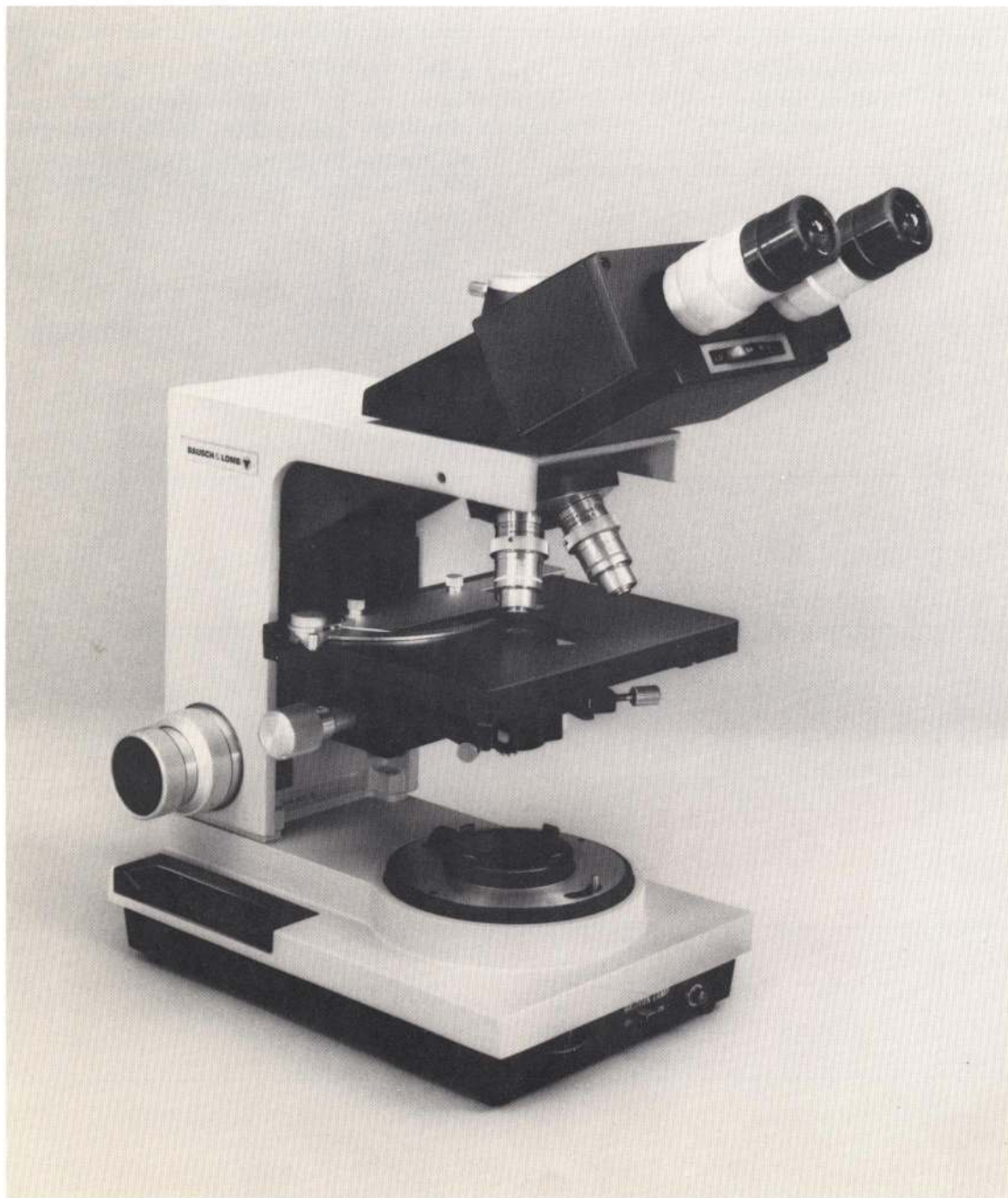

BAUSCH & LOMB BALPLAN MICROSCOPE WITH HIGH INTENSITY BASE ILLUMINATOR

SECTION - 1

Unpacking and Preparation For Use

This Microscope has been packed to ensure that it reaches you in the best possible condition. Notice that a translucent plastic dust cover for the Microscope has been packed with the Microscope.

When you have read this section and have finished assembling the instrument, carefully check all packaging material for any small items that may have been overlooked before discarding the cartons.

Remove the Microscope Stand from its packaging. The Stand is shipped with the Stage, Illuminator, and Lower Base or Cover in place, Fig. 1-1.

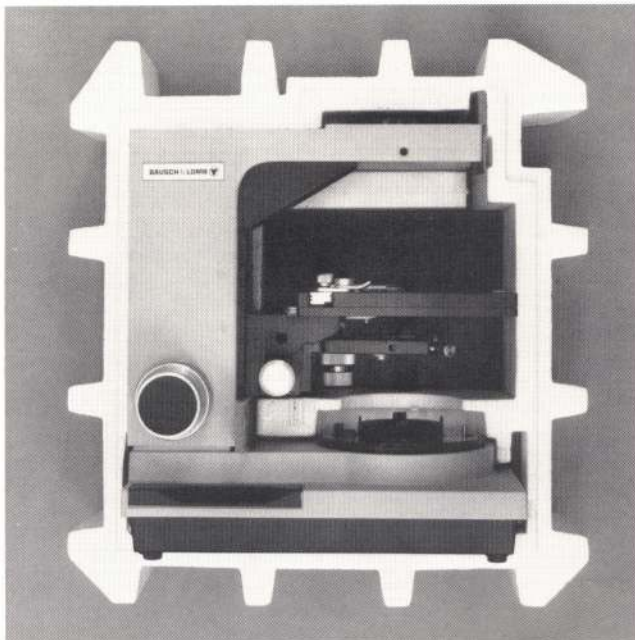

FIG. 1-1 - BALPLAN MICROSCOPE IN SHIPPING CASE

If the Microscope is equipped with either a High Intensity Base Illuminator, Cat. No. 31-32-16 or 31-32-38 (240V), or a Professional Optilume, Cat. No. 31-32-15 or 31-32-37 (240V), the Lower Base on the Microscope contains a built-in transformer and controls. The Power Cord is a three-wire cord and should be connected to the back of the Illuminator and to a grounded 120V. A.C. outlet.

The Power Cord for 240 volt models is already attached to the Illuminator base.

A Hexagonal Wrench for adjusting the Stage and Substage stops and for attaching the Nosepiece is included. It is sealed in an envelope which is packed in the accessory carton.

The Condenser ordered with the Microscope is in an accessory carton. To install the Condenser, first, rack the Substage down. It may be necessary to loosen the Substage Bottom stop, using the Hexagonal Wrench provided, to allow the Substage to be racked down. The Condenser can now be

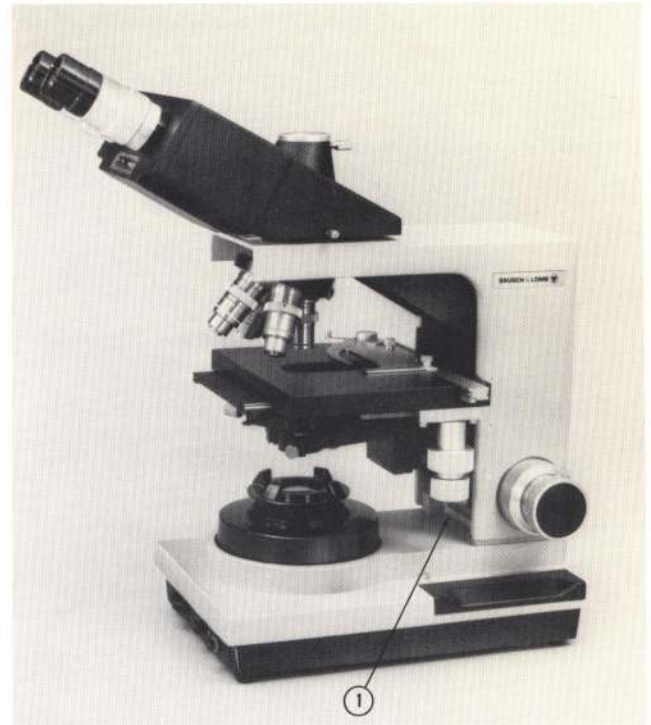

FIG. 1-2 - BALPLAN MICROSCOPE EQUIPPED WITH PROFESSIONAL OPTILUME

1. Serial No.

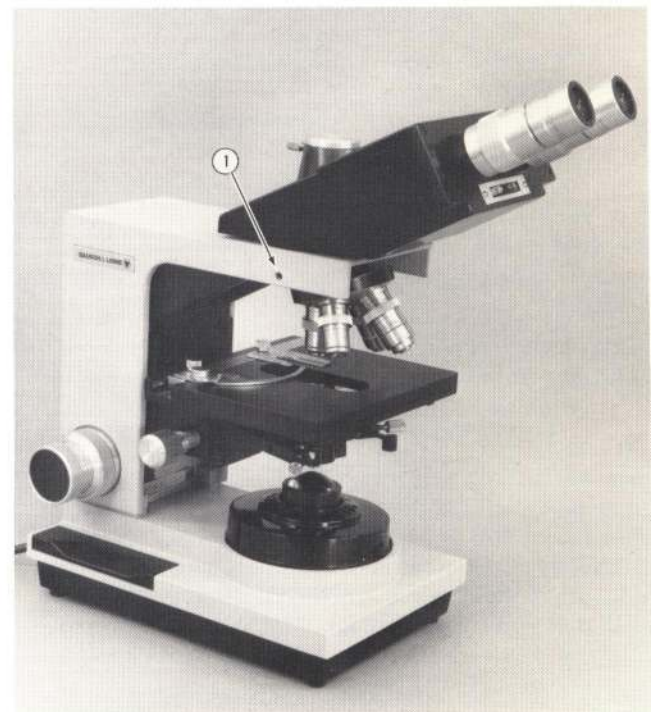

FIG. 1-3 - BALPLAN MICROSCOPE

1. Hole for Wrench

SECTION - 2

Operating Procedure

The following description will assist you in achieving maximum performance from your Microscope. If you have acquired more than one set of Eyepieces, select the Eyepiece which has the lowest magnification and insert it into the Eyepiece Tube. Rotate the Nosepiece until a low power Objective, preferably the 10X, is in viewing position. Place a specimen slide on the Stage, manipulating the specimen to the approximate center of the Stage opening. Turn on the light source.

FOCUSING

The left Eyepiece Tube is individually focusable by means of the Knurled Collar, Fig. 2-1, so that equally sharp images on both the left and right side may be attained. Focus the Microscope with the Focusing Adjustment, Fig. 2-1, until the right image appears sharp to your right eye. Then, without changing the Focus Adjustment, adjust the left Eyepiece until the image appears sharp in your left eye. The Microscope is now adjusted properly for your eyes.

Having located an area of interest on the specimen and focusing on it sharply, you may now swing a higher power Objective (on the Nosepiece) into place, since the Objectives are parfocal.

If you desire a still higher power, you may insert higher power Eyepieces.

The Microscope has a safety clutch action at the limit of the focusing motion. Should it be inadvertently focused too close so that the Objective contacts the Cover Glass, this feature will prevent serious damage to the instrument. Refer to Section - 16, Safety Clutch Adjustment, for instructions on the adjustment of this mechanism.

FIELD ILLUMINATION CONTROL

The High Intensity Base Illuminator has an integral Field Iris Diaphragm, Fig. 2-1. The image of this Diaphragm should be centered for optimum performance. To center the image of the Diaphragm, rotate the Nosepiece until the 10X Objective is in viewing position, and focus on the specimen. If there is a Flip-In Lens, Cat. No. 31-55-14, mounted on the bottom of the Condenser, make sure it is removed from the optical path, Fig. 2-1. Close the Field Iris Diaphragm to the half-open position by rotating the knurled wheel, Fig. 2-1. Vary the Condenser height until the sharpest possible image of the Field Iris Diaphragm is formed on the specimen. It will be unnecessary to vary the Condenser height for the other Objectives so long as you continue to observe specimen slides of the same thickness. Specimen slides should be no thicker than 1.25mm for optimum use of the Field Diaphragm.

Now proceed to open the Field Iris Diaphragm until the image is barely visible in the field of view. Center the image by manipulating the two knurled Centering Screws on the Substage, Fig. 2-1. The opening of the Diaphragm should be adjusted to the point where its image is just out of the field of view. For best results, the Field Iris Diaphragm should be recentered and readjusted each time a different Objective is

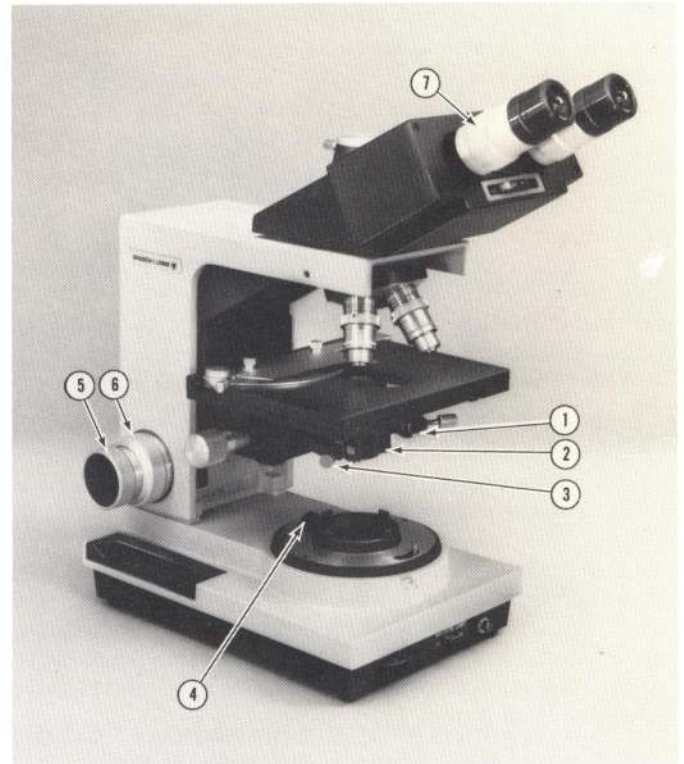

FIG. 2-1 - BALPLAN MICROSCOPE EQUIPPED WITH HIGH INTENSITY ILLUMINATOR

1. Aperture Diaphragm
2. Flip-In Lens
3. Centering Screws
4. Field Diaphragm
5. Fine Focus
6. Coarse Focus
7. Knurled Collar

used. Under these conditions, your Microscope will be functioning in accordance with the Koehler Illumination Principles.

If your Microscope is equipped with the Professional Optilume, it will not have Field Illumination control.

APERTURE ILLUMINATION CONTROL

The Aperture Iris Diaphragm, Fig. 2-1, is the principal control at your disposal for modifying the image quality of the Microscope. Opening and closing this Iris changes the angle of the cone of illumination entering the Objective. This modifies contrast, resolving power and depth of focus. Accordingly, it is of fundamental importance that its proper use be clearly understood.

If the Iris is closed all the way, contrast and depth of focus are generally at a maximum, but resolving power and brightness are at a minimum. As the Iris is opened, contrast and depth of focus decrease but resolving power and brightness increase. Since clarity of seeing is dependent on all of these factors, it is apparent that one should set the

SECTION 2. OPERATING PROCEDURE

aperture Iris for the best compromise possible.

The Iris should not be used to control brightness. Other means, such as voltage control or filters, should be used instead. Using the Iris to control brightness will impair its effectiveness in controlling contrast, resolving power and depth of focus since the aperture selected for desired brightness may not be the setting necessary to optimize the other factors.

The Aperture Diaphragm should not be opened wider than is sufficient to fill the objective with light (tested by looking at the back lens of the Objective after removing the Eyepiece), and generally it is advisable to start with only about two-thirds of the back lens of the Objective filled with light. From this starting point, open and close the Diaphragm until the best compromise is obtained between resolution and contrast.

In the examination of most microscopic preparations, the problem is to differentiate low contrast structure, which is difficult to see because its color or opacity differs so little from its surroundings, rather than to observe detail at the limit of resolution of the Objective. The skillful use of the Aperture Diaphragm will be extremely helpful in examining such specimens by bringing out the optimum definition in the image. Often different Diaphragm settings are required for different types of detail within the same preparation. Experience and study are required to learn the most effective use of the Diaphragm.

CONDENSER WITH OIL IMMERSION OBJECTIVES

It has often been stated that little is gained in using an Oil Immersion Objective unless the Condenser is oil immersed. This is not so. Experience has shown that the most satisfactory image is the result of a compromise between resolution and contrast, and that this is obtained when the Objective is used at about 2/3 of its maximum aperture. This condition is almost automatically established when an Oil Immersion Objective is used with a dry Condenser. It is therefore common practice to use Oil Immersion Objectives without immersing the condenser. The Objective, of course, must always be immersed.

It is true, however, that the Objective will be unable to deliver its maximum resolving power unless its back aperture is filled with light, and this condition cannot be satisfied for an Oil Immersion Objective unless the Condenser is also oil-contacted to the slide. To accomplish this, lower the Condenser slightly, place a drop of oil on the top lens of the Condenser, place the slide on the Stage and then bring up the Condenser with the Focusing Adjustment until contact of oil and slide is established. The Illuminator adjustments described earlier should now be repeated.

THE COVER GLASS

The Cover Glass, which is normally placed over the specimen, might appear to be a rather insignificant item and little consideration given to it in the preparation of the specimen slide. This, however, is far from true, as the Cover Glass becomes an integral part of the optical system, especially when dealing with high power dry Objectives. All Bausch & Lomb Balplan Microscope Objectives have been designed to be used with 0.18mm thick, plane-parallel Cover Glass having a refractive index of $n_D 1.522$.

Variations of only a very few hundredths of a millimeter in thickness from the nominal 0.18mm are sufficient to cause a marked deterioration of image contrast when using the 40X, 0.65 NA Objectives or higher power. The change in aberration correction (spherical aberration, primarily) with respect to Cover Glass thickness increases exponentially with numerical aperture for dry Objectives. Low power Objectives having N.A.'s of 0.25 or less are much less sensitive to Cover Glass thickness. Oil Immersion Objectives are also insensitive because the oil and glass are almost homogeneous in refractive index. However, Oil Immersion Objectives have a very short working distance (distance from front of the Objectives to the specimens) and with too thick a Cover Glass, it will be impossible to focus on the specimen.

Cover Glasses are available from any laboratory supply house and are usually sold according to thickness. The usual commercial classifications are Nos. 1, 1-1/2, 2, and 3, the thickness range of each group being:

No. 1	0.13 to 0.17mm thick
No. 1-1/2	0.16 to 0.19mm thick
No. 2	0.17 to 0.25mm thick
No. 3	0.25 to 0.50mm thick

Cover Glasses No. 1, 1-1/2, and 2 are the ones used most commonly.

No. 1 Cover Glasses, because of their thickness, are preferable for use with Oil Immersion Objectives, but No. 1-1/2 Cover Glasses may also be used with these Objectives.

The No. 2 Cover Glass is a general purpose glass used for examining specimens under low power dry Objectives, the thicker slips in this group being used for the lower powered Objectives.

SECTION - 3 Head Types

Heads are directly interchangeable on the Microscope Stand. The Heads are designed for use with Bausch & Lomb Planachromat Objectives. They are rotatable through 360°. A Clamp Screw, Fig. 3-1, permits locking the Head at any point in its 360° rotation.

Head types include:

Triocular	30°*	Cat. No. 31-18-79
Binocular	45°*	Cat. No. 31-18-91
Binocular	30°*	Cat. No. 31-18-77
Photobinocular	30°*	Cat. No. 31-18-14

To set the Eyepiece Tubes of the Binocular Head for the proper interpupillary distance, rotate the Knurled Wheel, Fig. 3-1, to the desired distance as indicated on the interpupillary scale. To determine your interpupillary distance setting, adjust the Knurled Wheel, until you are seeing the full field of view with both eyes. Check this by closing one eye and then the other without moving your head. After you have found the proper setting, record or remember it for future use.

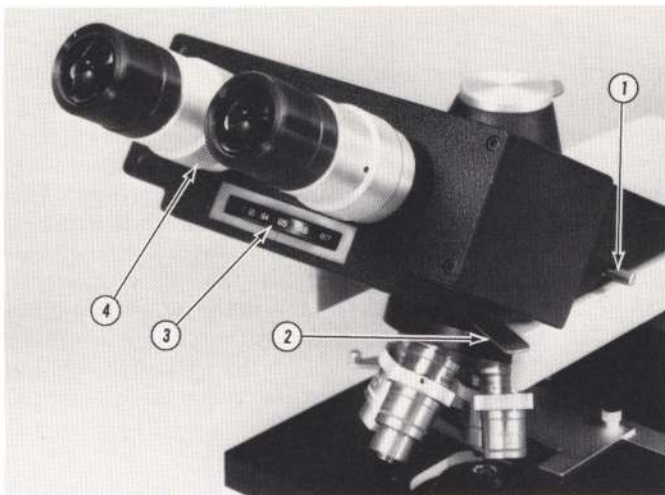

FIG. 3-1 - BALPLAN TRIOCULAR HEAD

1. Knurled Screw
2. Prism Control Lever
3. Knurled Wheel
4. Knurled Collar

As you adjust the interpupillary distance, the tube length remains constant. The effect of this is that there is no change in objective parfocality and no change in magnification. Measuring Eyepieces that have been calibrated remain in calibration for all interpupillary distances.

The left Eyepiece Tube of the Triocular Head, Photobinocular Head and the 30° Binocular Head, is individually focusable by means of the Knurled Collar, Fig. 3-1, so that equally sharp images on both the left and right side may be attained. To set them for your eyes, it is recommended that you use the lowest power Objective since the setting is most sensitive in this case. Focus the Microscope until the right

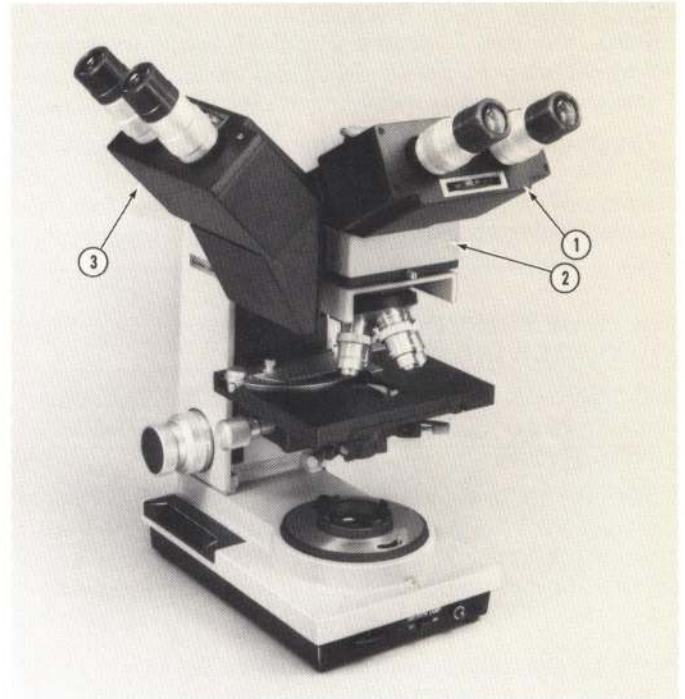

FIG. 3-2 - BALPLAN MICROSCOPE EQUIPPED WITH VIEWING ADAPTER

1. 30° Head
2. Dual Viewing Adapter
3. 45° Head

image appears sharp to your right eye. Then, without changing the focus adjustment, adjust the left Eyepiece until the image appears sharp in your left eye. The Microscope is now adjusted properly for your eyes.

The Triocular Head, Cat. No. 311879, is intended for photomicrographic use and has a movable Prism which directs all of the illumination to either the Camera for photomicrography or to the inclined Eyepieces for visual use. Push the Prism Control Lever, Fig. 3-1, away from you for visual use, and to switch from Visual to Camera use, move the Prism Control Lever toward you until it comes to a stop.

The Photobinocular Head, Cat. No. 311814 is intended for photomicrographic use or in combination with a closed circuit television system. A prism directs 50% of the light to eyepieces and 50% of the light to the camera port.

The 30° Binocular Head, Cat. No. 31-18-77, and the 45° Head, Cat. No. 31-18-91, are used with the Dual Viewing Adapter, Cat. No. 31-18-93, to provide dual viewing of a specimen, Fig. 3-2. The 30° Binocular Head should be used at the operator's position and the 45° Binocular Head should be used at the observer's position.

This results in a more comfortable eyepoint position for the observer.

*Eyepiece Inclination angle from the horizontal.

SECTION 3. HEAD TYPES

NOTE

Both Eyepiece Tubes are focusable and have Knurled Collars on the 45° Binocular Head. The Eyepiece Tubes should be set as follows:

Install 45° Binocular Head at the observer's position on the Dual Viewing Adapter. After the operator has focused the Microscope on the specimen, the observer should focus the Eyepiece Tubes up and down until the image of the specimen is sharp in both Eyepieces.

FOCUS OF POINTER (DUAL VIEWING ADAPTER, 311893)

Assembly has been focused at the factory, however, should you care to use the instrument without corrective lenses proceed as follows.

Turn the microscope on and push the switch on the side of the Dual Viewing Adapter. Articulate the handle until a green arrow appears in the field of view. If a green arrow does not appear, repush the switch and repeat the procedure. Focus the microscope on a slide using primary position.

Focus the secondary head on the slide by adjusting the eyepieces. Remove the primary head and insert a hex wrench (.035" across the flats) into the screw in the pointer, accessible through the hole in the top of the adapter (Fig. 3-4). Loosen the screw and with the wrench still inserted in the screw, rotate the screw 90° to the axis of the pointer. Using the secondary position for viewing, focus the pointer and tighten the screw.

FOCUS OF POINTER (MULTIPLE VIEWING ADAPTER, 311885)

Assembly has been focused at the factory, however, should you care to use the instrument without corrective lenses proceed as follows.

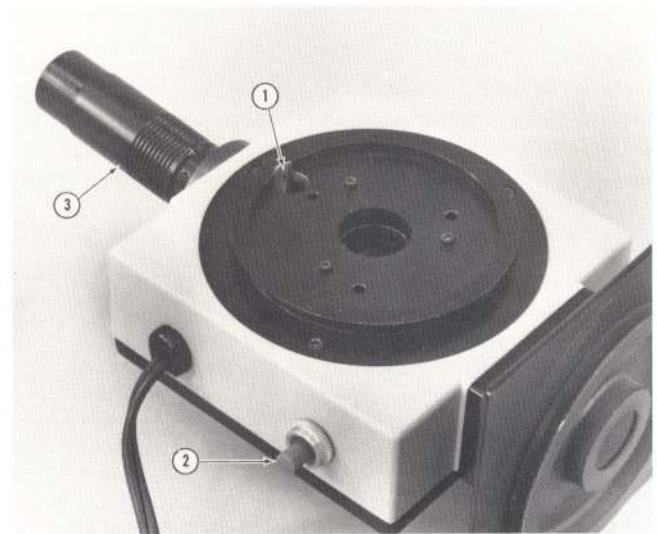

FIG. 3-3 - BALPLAN VIEWING ADAPTER

1. Hex Wrench Hole
2. Switch
3. Handle

Turn the microscope on and push the switch on the side of the Dual Viewing Adapter. Articulate the handle until a green arrow appears in the field of view. If a green arrow does not appear repush the switch and repeat the procedure. Focus the microscope on a slide using the primary head position. Focus the secondary head on the slide using the Focusing Knob on the top of the adapter. Remove the primary head and insert a wrench into the screw in the pointer, accessible through the hole in the top of the adapter (Fig. 3-4). Loosen the screw and with the wrench inserted in the screw, rotate the screw 90° to the axis of the pointer. Using the side position for viewing, focus the pointer and tighten the screw.

SECTION - 4 Objectives and Eyepieces

The following table gives data pertaining to the Balplan Objectives combined with three types of Eyepieces.

The 10X Wide Field Focusable Eyepiece, Cat. No. 31-15-67, has the same optical characteristics, as the 10X Wide Field Eyepiece, Cat. No. 31-15-61, and has a focusable lens.

A Reticle may be installed in the Eyepiece by screwing the lens out, dropping the Reticle onto the Diaphragm, pattern side down, and installing the spring ring on top of the Reticle. Screw the lens in and focus on the Reticle.

MAGNIFICATIONS AND REAL FIELDS

PLANACHROMATIC						
OBJECTIVES				EYEPIECES		
CAT. NO.	MAGNIFICATION	NUMERICAL APERTURE	WORKING DISTANCE	10X WIDE FIELD CAT. NO. 31-15-61		15X WIDE FIELD CAT. NO. 31-15-62
31-12-20	2.5X	0.0625	9.17mm	a	25X	37.5X
				b	8.0	6.7
				c	23.5	11.4
31-13-21	4X	0.09	9.20mm	a	40X	60X
				b	5.0	4.2
				c	23.7	11.5
31-12-22	10X	0.25	1.02mm	a	100X	150X
				b	2.0	1.7
				c	23.7	
31-12-19	10X	0.25	9.95mm	a	100X	150X
				b	2.0	1.7
				c	23.7	11.6
31-12-23	20X	0.50	0.62mm	a	200X	300X
				b	1.0	0.84
				c	23.7	11.5
31-12-24	40X	0.65	0.51mm	a	400X	600X
				b	0.5	0.42
				c	23.7	11.5
31-12-28	50X Oil	0.80	0.39mm	a	500X	750X
				b	0.40	0.22
				c	23.7	11.5
31-12-26	100X	1.25	0.10mm	a	1000X	1500X
				b	0.2	0.17
				c	23.5	11.4

SECTION 4. OBJECTIVES AND EYEPIECES

MAGNIFICATIONS AND REAL FIELDS

PLANACHROMATIC OBJECTIVES						
FOR PHASE CONTRAST				EYEPIECES		
CAT. NO.	MAGNIFICATION	NUMERICAL APERTURE	WORKING DISTANCE	10X WIDE FIELD CAT. NO. 31-15-61		15X WIDE FIELD CAT. NO. 31-15-62
31-12-40	10X	0.25	5.70mm	a	100X	150X
				b	2.0	1.7
				c	23.7	11.6
31-12-41	20X	0.50	0.61mm	a	200X	300X
				b	1.0	0.84
				c	23.7	11.5
31-12-42	40X	0.65	0.51mm	a	400X	600X
				b	0.5	0.42
				c	23.7	11.5
31-12-43	100X	1.25	0.10mm	a	1000X	1500X
				b	0.2	0.17
				c	23.5	11.4

a = Total Magnification of Objective/Eyepiece combination.

b = Diameter of Field of View in Specimen Plane, in mm.

c = Eye Relief, in mm.

CUSTOMER PARFOCALIZING OBJECTIVES

CAT. NO. 31-12-24 40X PLANACHROMAT
 CAT. NO. 31-12-26 100X PLANACHROMAT

Customer adjustable 40X and 100X Objectives can be parfocalized in the following manner. Refer to Figs. 4-1 and 4-2.

Focus the microscope on an object using a 10X Objective and the fixed side of the Binocular head. Index to the 40X or 100X Objective and loosen the Lock Screw "A" with the "Hex" wrench provided (Fig. 4-1).

Inserting a screwdriver into the Focusing Screw "B," and turning slowly, accurately focus on the object (Fig. 4-2). The Lock Screw "A" should then be tightened.

NOTE

It may be necessary to remove an adjacent objective if its position makes the Lock Screw and Focusing Screw inaccessible.

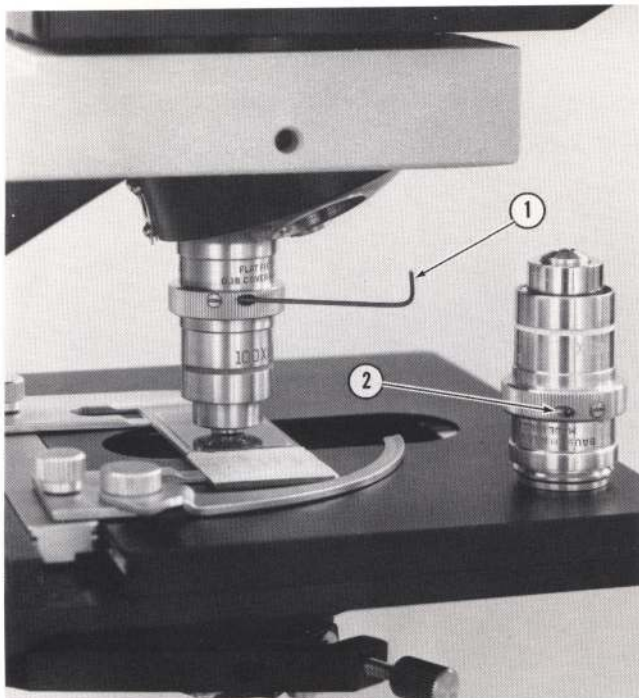

FIG. 4-1 - 40X AND 100X PLANACHROMAT OBJECTIVE

1. Hex Wrench
2. Lock Screw "A"

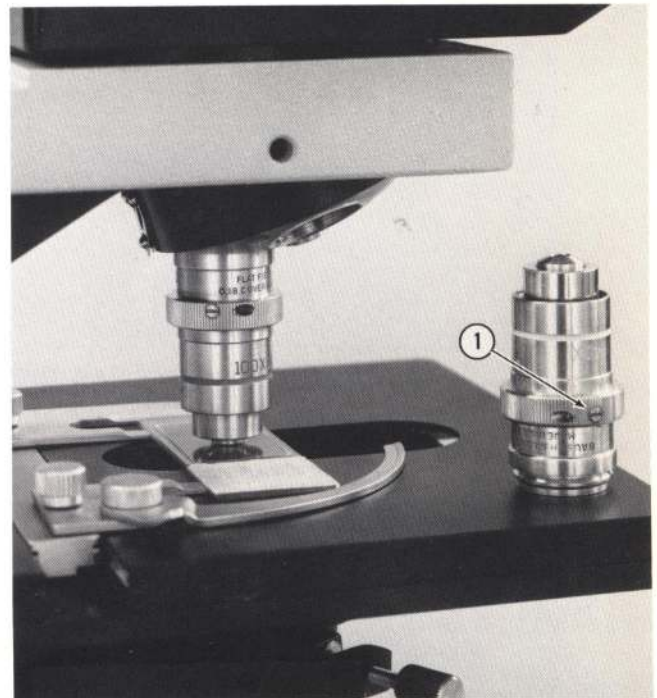

FIG. 4-2 - 40X AND 100X PLANACHROMAT OBJECTIVE

1. Focusing Screw "B"

SECTION - 5 Stage Types

There are several types of Stages available and include:

Plain Stage with Rack and Pinion Substage, Cat. No. 31-60-12, Fig. 5-1.

Integral Graduated Mechanical Stage with Rack and Pinion Substage - Right Hand, Cat. No. 31-60-43, Left Hand, Cat. No. 31-60-45, Fig. 5-2.

Integral Ungraduated Mechanical Stage with Rack and Pinion Substage. Right Hand, Cat. No. 31-60-42, Left Hand, Cat. No. 31-60-44, Fig. 5-3.

All Stages are interchangeable. To accomplish this, remove the Objectives to eliminate interference. Remove the Condenser and rack the Substage completely upward. Remove the two screws in the face of the Stage Support, Fig. 5-8. Rack the Stage to the bottom of its travel. The Stage may now be lifted vertically.

NOTE:

A slight jarring upward may be required to free the Stage from the key. To replace the Stage reverse the procedure. The key will position the Stage correctly. Be sure to replace the two screws in the face of the Stage Support.

TO SET THE STAGE STOP

Place a specimen slide of the thickness which will be most commonly used in position on the Stage below the Objective. Rotate the Nosepiece until the highest power Objective is in viewing position. Loosen the Stage Stop Lock Screw, Fig. 5-4, with the Hexagonal Wrench supplied. Raise the Stage until the specimen is in focus in the Eyepiece. Remove the specimen slide. Using the Fine Focus Adjustment, raise the Stage four revolutions of the Fine Focus Knob. Retighten the Stage Stop Lock Screw.

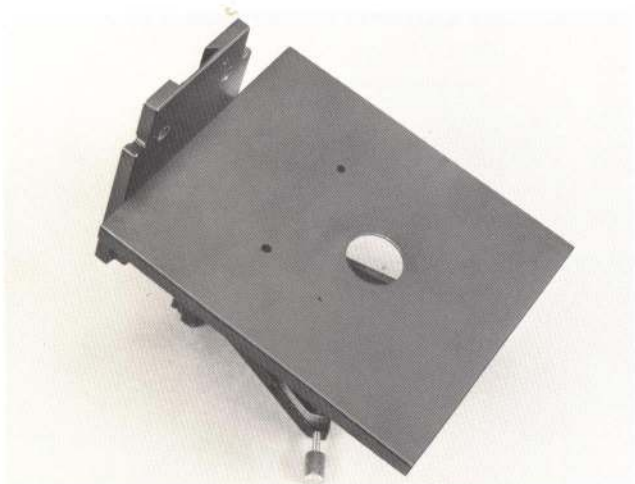

FIG. 5-1 - BALPLAN PLAIN STAGE WITH RACK AND PINION SUBSTAGE

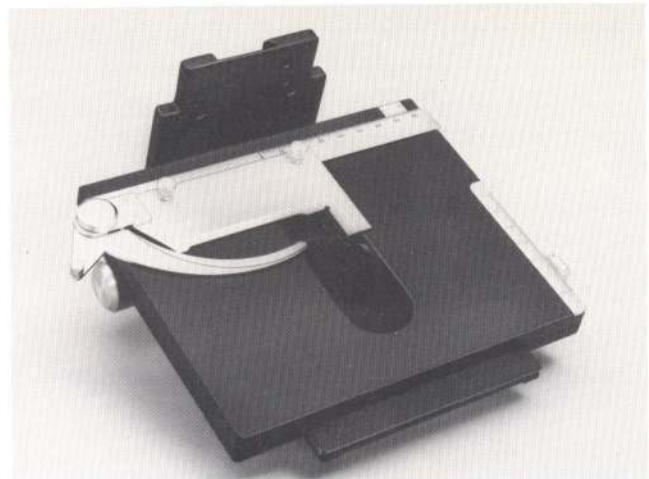

FIG. 5-2 - BALPLAN INTEGRAL GRADUATED MECHANICAL STAGE



FIG. 5-3 - BALPLAN INTEGRAL UNGRADUATED MECHANICAL STAGE

STAGE CLIPS

Stage Clips for use with the Plain Stage are packed in the accessory carton. They should be pressed into the holes provided in the top surface of the Stage.

MECHANICAL STAGES

The Integral Mechanical Stages hold the slide in place by a spring-loaded finger which secures the slide against a Slide Holder Assembly. The slide motion is controlled by the concentric Stage Control Knobs, Fig. 5-4, on the large vertical shaft. The motion is adequate to cover a 2" by 3" specimen slide. The verniers on the Graduated Mechanical Stages are graduated to 1.0mm and permit readings to 0.1mm. This feature makes it possible to record the location of a particular area of a slide for later reference. Length and

separation measurements may also be made with this device. An unobstructed Stage surface for the hand scanning of slides with a low power Objective is available by loosening the knurled screws holding the slide holders to the Stage and removing the holders from the Stage surface.

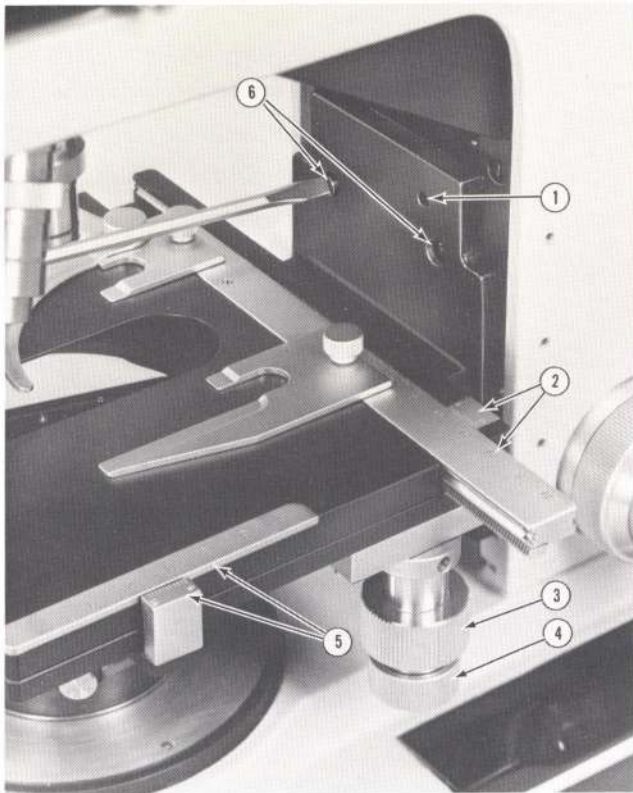

FIG. 5-4 - BALPLAN INTEGRAL GRADUATED MECHANICAL STAGE

1. Stage Stop Lock Screw
2. Verniers
3. Stage Control Knob
4. Stage Control Knob
5. Verniers
6. Stage Support Screws

SUBSTAGES

If your Microscope is equipped with a High Intensity Base Illuminator, Knurled Head Centering Screws are supplied for centering the Substage, Fig. 5-6. If your Microscope includes an Illuminator with no Field Diaphragm, such as the Professional Optilume, the Substage will have been centered at the factory. Should it be desired to make a slight readjustment, the Centering Screws may be repositioned by use of the Hexagonal Wrench supplied with the instrument.

Each Rack and Pinion Substage has an easily adjustable Focusing Stop, Fig. 5-5. This feature is most advantageous when various types of Condensers are to be used on the Microscope. The Focusing Stop should be set so that the Condenser never rises above the Stage surface or contacts the specimen slide. To adjust the Stop, loosen the Focusing Stop Lock Screw, Fig. 5-5, slightly with the Hexagonal

Wrench provided. Position the Condenser at the desired maximum height and retighten the Lock Screw. Each Rack and Pinion Substage also has a Down Stop, Fig. 5-6, to prevent interference of various condensers and Illuminators. To adjust the Stop, loosen the Stop Lock Screw, Fig. 5-6, with the wrench provided. Position the Condenser at the lowest position desired and retighten the Lock Screw.

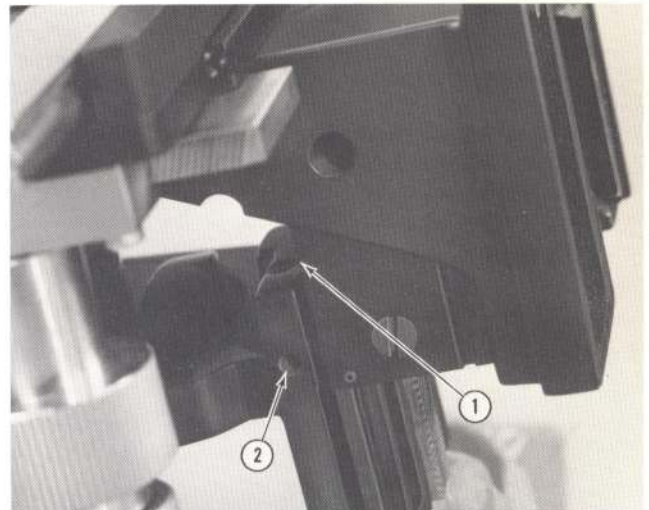

FIG. 5-5 - BALPLAN SUBSTAGE

1. Substage Up Stop
2. Substage Up Stop Lock Screw

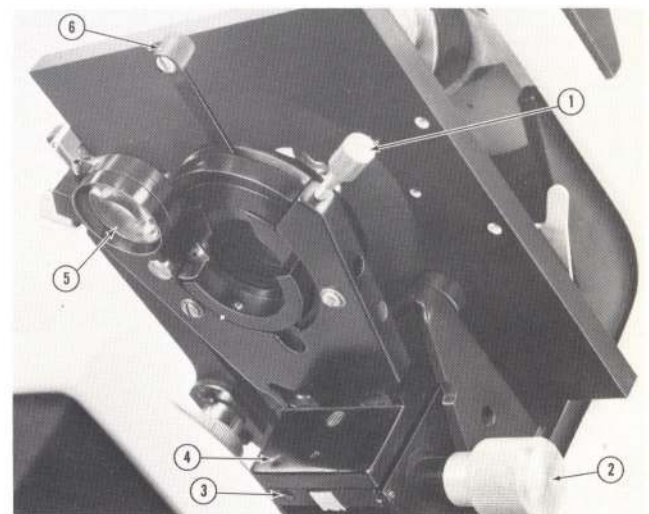

FIG. 5-6 - BALPLAN SUBSTAGE

1. Substage Centering Screws
2. Substage Focusing Knob
3. Substage Down Stop
4. Down Stop Lock Screw
5. Flip-In Lens
6. Iris Diaphragm Control

SECTION - 6 Substage Condensers

The function of the Substage Condenser is to direct a light beam of the desired numerical aperture and field size onto the specimen. There are several types of Condensers as follows:

The 1.25 N.A. Aplanatic Condenser with Iris Diaphragm, Cat. No. 31-55-13 (Fig. 6-1), is primarily for use with High Intensity Base Illuminator, Cat. No. 31-32-14.

The 1.25 N.A. Flip-Out Condenser and Iris Diaphragm, Cat. No. 31-55-15 (Fig. 6-1), is required when using the 2.5X Objective in order to fill the field and aperture.

The Paraboloid Dark Field Condenser is discussed under Section 14, Dark Field Microscopy.

Turret Phase Condensers and Long Working Distance Phase Condensers are discussed in Section 12, Phase Contrast Microscopy.

A Flip-In Lens Attachment, Cat. No. 31-55-14 (Fig. 6-1) mounts on the 31-55-13 Condensers to permit filling the field of a 4X Objective.

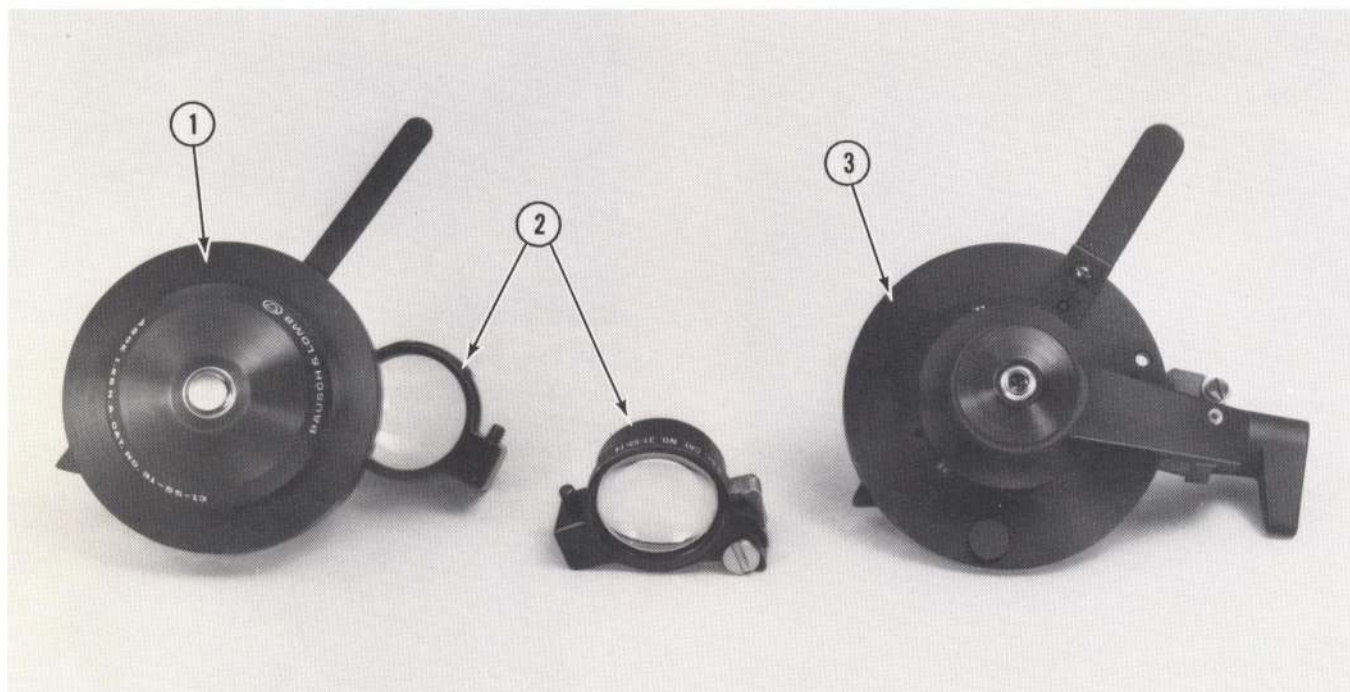

FIG. 6-1 - BALPLAN SUBSTAGE CONDENSERS

1. 1.25 Aplanatic Condenser
2. Flip-In Lens
3. 1.25 N.A. Flip-Out Condenser

SECTION - 7 Illuminators

CAUTION

Always disconnect the cord from the power supply before attempting any adjustment or interchange of illuminators.

Your Balplan Microscope will be equipped with one of the following Illuminators:

1. High Intensity Base Illuminator, Cat. No. 31-32-16 (120V).
2. Professional Optilume, Cat. No. 31-32-15 (120V).
3. High Intensity Base Illuminator, Cat. No. 31-32-38 (240V).
4. Professional Optilume, Cat. No. 31-32-37 (240V).

These bases with the built-in Illuminators may be removed by removing the three screws from the bottom, Fig. 7-1, if necessary for installing a different Illuminator. The Bottom Cover may be removed by removing the three screws, Fig. 7-3.

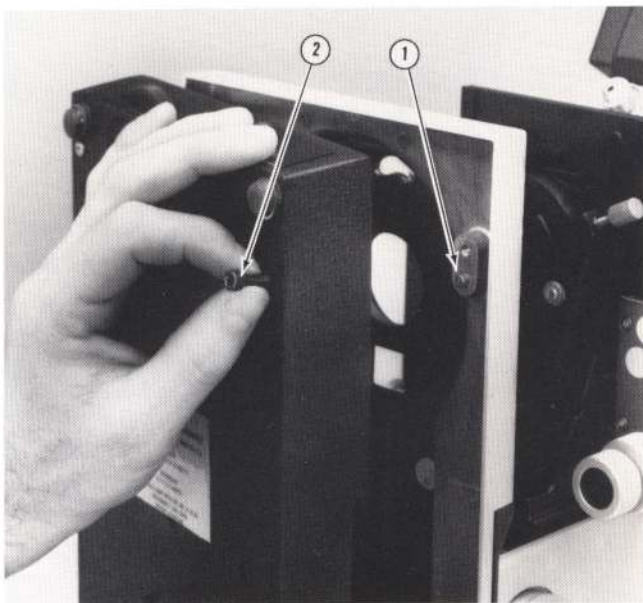

FIG. 7-1 - BALPLAN HIGH INTENSITY BASE

1. Locating Dowel
2. Removable Screws (3)

THE HIGH INTENSITY BASE ILLUMINATOR, CAT. NO. 31-32-16

The Base Illuminator provides high intensity Koehler Illumination which is achieved through the use of a low voltage lamp combined with a high Speed Lens Condensing System, and a Field Iris Diaphragm. A Flip-In 1.0 Neutral Density Filter is built into the Illuminator, and 2" round or square filters may be inserted in the top of the Illuminator.

NOTE:

The bulb used with the High Intensity Base Illuminator is rated at 6.5 volts, 2.75 amps (Cat. No. 31-31-42). The third black button to the right supplies 6.5 volts. The white

button is for photomicrography but its use will shorten lamp life. For maximum lamp life, use the lowest voltage which permits comfortable viewing.

When ordered with the Microscope, the Illuminator is fastened in position within the Base. When the Illuminator is ordered as a separate item it is necessary to install it on the Microscope as follows:

Remove the Base, or Bottom Cover, whichever your Microscope is equipped with. The High Intensity Base Illuminator can now be installed. The two dowels in the upper Base ensure the alignment, Fig. 7-1. The upper portion of the Illuminator, Cat. No. 31-32-04, and 31-32-14 is secured to the Base by two screws holding two clamps, Fig. 7-5. This should be installed first.

Both Illuminators have a receptacle that accepts the plug from the Wire Harness (Cat. No. 31-32-98). See Section 9. This should be installed next and then the Base located on the dowels and the screws tightened.

Condenser Centering Screws are furnished to replace the Socket Head Set Screws shipped with the Microscope, Fig. 7-2.

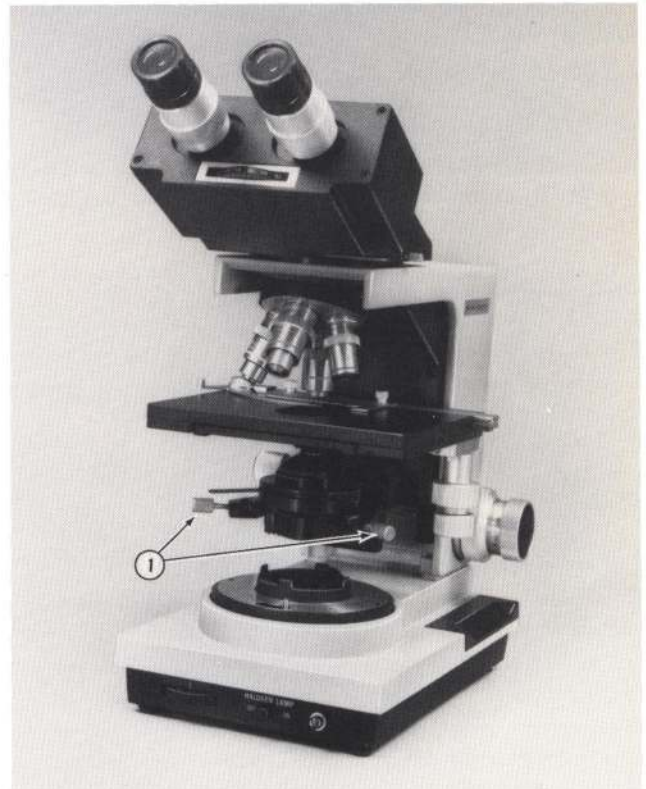

FIG. 7-2 - BALPLAN WITH HIGH INTENSITY BASE ILLUMINATOR

1. Substage Centering Screws

SECTION 7. ILLUMINATORS

A final adjustment of lamp position must be made to ensure maximum performance. Use the 10X Objective and the lowest power Eyepieces available to make this adjustment. Turn on the Illuminator and, looking in the Eyepieces, adjust the position of the lamp filament along the axis of motion (in and out) until the entire field of view is evenly illuminated. Set the Stop Screw to repeat this position, if desired. Satisfactory results will generally be obtained with all other Objectives by leaving the filament in the initial position. However, to obtain maximum performance for critical observation, it is recommended that the lamp filament position be adjusted for each individual Objective, adjusting the lamp to give the best balance between evenness and brightness.

To replace a lamp in the Base Illuminator, Cat. No. 31-32-14, withdraw the Socket Assembly from the rear of the Base by pulling on the flanged end. On the Cat. No. 31-32-04 it is necessary to first remove the Guard, Fig. 7-6, by removing the two Screws before withdrawing the Socket Assembly. Be sure to replace the Guard after replacing the Socket Assembly. Tip the lamp slightly and turn it counterclockwise to release it from the retaining pins. Insert a new lamp, Cat. No. 31-31-42. There is only one lamp position in which the three pins will engage. A partial clockwise turn will lock the lamp in place. Reinsert the unit into the Microscope Base. Push forward until it stops against the Stop Screw.

THE PROFESSIONAL OPTILUME, CAT. NO. 31-32-13

The Professional Optilume provides variable intensity illumination by the use of a low voltage lamp and a high speed Lens Condensing System. It has a built-in daylight filter and 2" round or square filters may be inserted in the top of the illuminator.

NOTE

The bulb used with the Professional Optilume is rated at 6.5 volts, 2.75 amps (Cat. No. 31-31-85). The third black button to the right supplies 6.5 volts. The white button is for photomicrography, but its use will shorten lamp life. For maximum lamp life, use the lowest voltage which permits comfortable viewing.

CAUTION

Always disconnect the cord from the power supply before attempting any adjustment or interchange of illuminators.

When ordered with the Microscope, the Illuminator is fastened in position with the Base. When the Illuminator is ordered as a separate item, it is necessary to install it on the Microscope as follows:

Remove the Base, or the Bottom Cover, whichever your Microscope is equipped with (see above).

The Illuminator Base has a receptacle that accepts the plug from the Wire Harness (Cat. No. 31-32-98). See Section 9. This should be connected.

The Professional Optilume can now be installed. The two dowels in the upper Base ensure alignment, Fig. 7-1. The

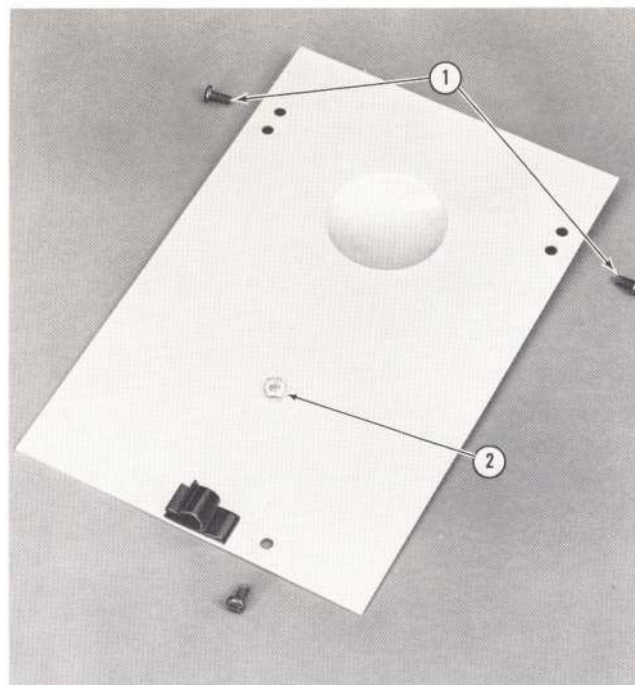

FIG. 7-3 - BOTTOM COVER

1. Screws
2. Ground Connector

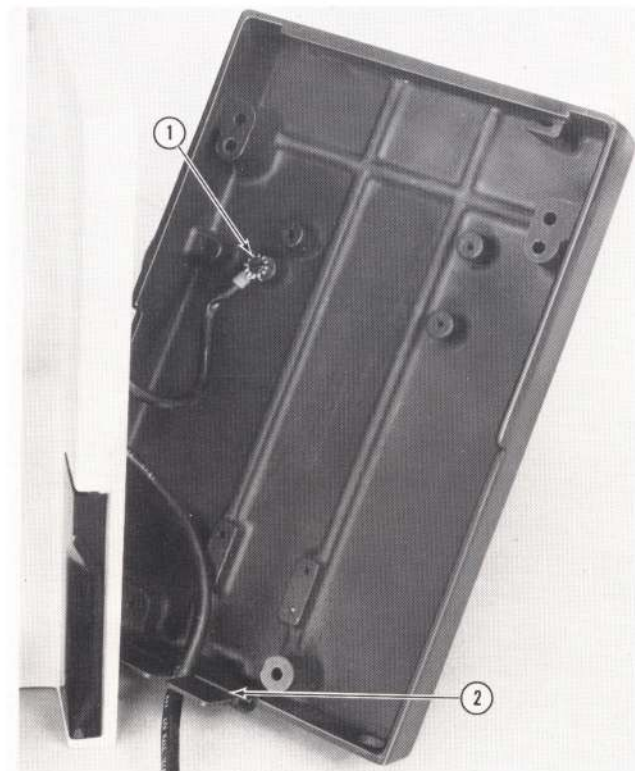

FIG. 7-4 - GROUNDING BALPLAN OPTILUME

1. Ground Wire
2. Plastic Slotted Plug

upper portion of the Illuminator fits into the upper Base from the top.

To replace the Lamp, Cat. No. 31-31-85, in the Professional Optilume, remove the upper portion of the Illuminator by turning slightly counterclockwise and lifting. The Lamp will then be exposed. Tip the Lamp slightly and turn it counterclockwise to release it from the retaining pins. Insert a new lamp, Cat. No. 31-31-85. There is only one Lamp position in which the three pins will engage. A partial clockwise turn will lock the Lamp in place.

THE PROFESSIONAL OPTILUME CAT. NO. 31-32-03 (for use in Canada)

The Professional Optilume provides variable intensity illumination by the use of a low voltage lamp and a high speed Lens Condensing System. It has a built-in daylight filter and 2" round or square filters may be inserted in the top of the Illuminator.

NOTE

The bulb used with the Professional Optilume is rated at 6.5 volts, 2.75 amps (Cat. No. 31-31-85). The third black button to the right supplies 6.5 volts. The white button is for photomicrography, but its use will shorten lamp life. For maximum lamp life, use the lowest voltage which permits comfortable viewing.

CAUTION

Always disconnect the cord from the power supply before attempting any adjustment or interchange of illuminators.

When ordered with the Microscope, the Illuminator is fastened in position with the Base. When the Illuminator is ordered as a separate item, it is necessary to install it on the Microscope as follows:

Remove the Base, or the Bottom Cover, whichever your Microscope is equipped with (see above).

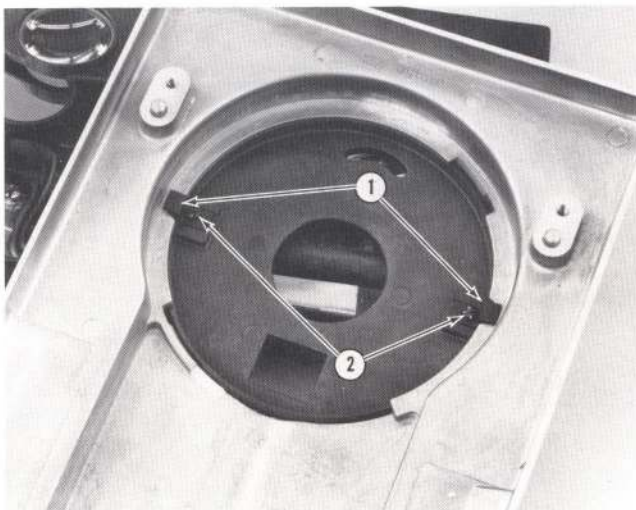

FIG. 7-5 - HIGH INTENSITY BASE ILLUMINATOR

1. Clamp
2. Screw

The upper portion of the Illuminator is secured to the Base by two Screws holding two Clamps, Fig. 7-7.

The Illuminator Base has a receptacle that accepts the plug from the Wire Harness (Cat. No. 31-32-98). See Section 9. This should be connected.

The Professional Optilume can now be installed. The two dowels in the upper Base ensure alignment, Fig. 7-1. The upper portion of the Illuminator fits into the upper Base from the top.

To replace the lamp (Cat. No. 31-31-85) in the Professional Optilume, it will be necessary to remove the lower Base to gain access to the bulb.

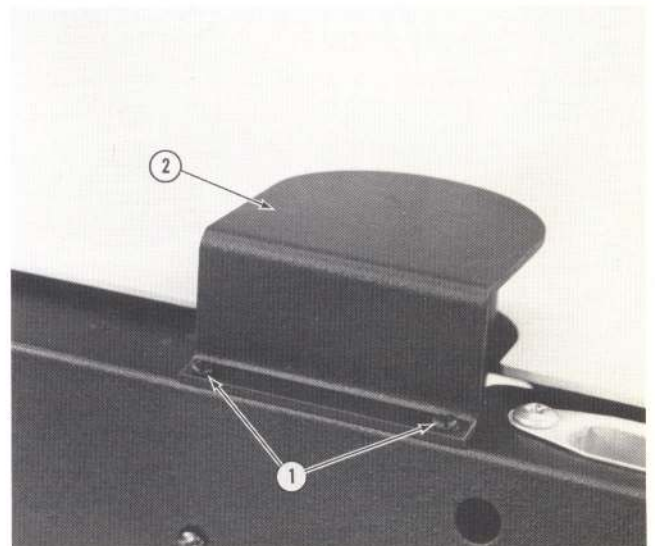

FIG. 7-6

1. Guard
2. Screws

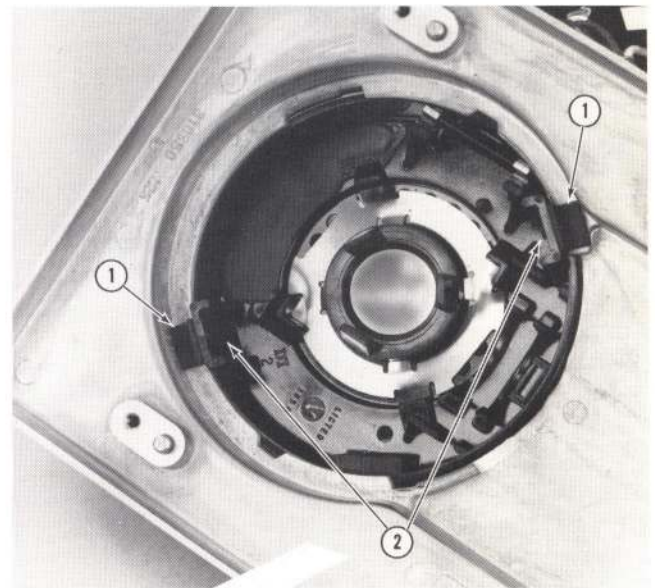

FIG. 7-7 - PROFESSIONAL OPTILUME

1. Clamp
2. Screws

SECTION 7. ILLUMINATORS

Your BALPLAN Microscope will be equipped with one of the following Illuminators:

HIGH INTENSITY BASE ILLUMINATOR, Cat. Nos. 31-32-16, 31-32-06, and 31-32-38 (Fig. 7-8).

Accessories

1. Wire Harness, Cat. No. 31-32-93.
2. Lamp, 20-Watt Halogen, Pack of 1, Cat. No. 31-31-81-01.
3. Lamp, 20-Watt Halogen, Pack of 10, Cat. No. 31-31-81-10.

The High Intensity Base Illuminators are for use with the nominal voltages listed below.

Cat. No. 31-32-16 120V - 50/60 Hz

Cat. No. 31-32-38 240V - 50/60 Hz

And Cat. No. 31-32-06 120V - 50/60 Hz
For Use in Canada

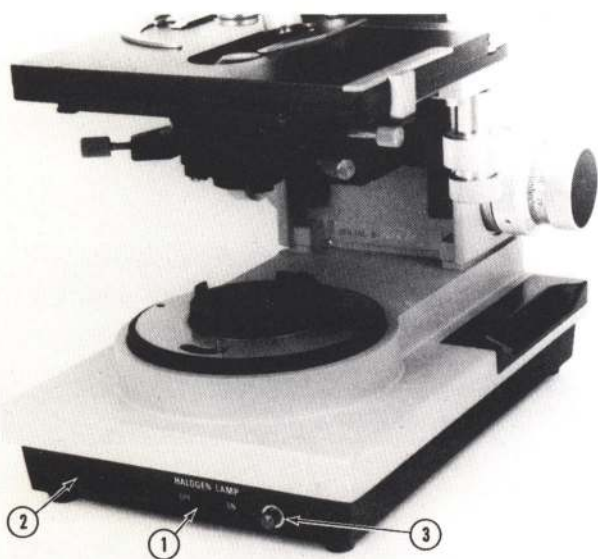

FIG. 7-8 - BALPLAN WITH HIGH INTENSITY BASE ILLUMINATOR

1. Switch
2. Control Knob
3. Indicator Light

The High Intensity Base Illuminator provides Koehler Illumination which is achieved through the use of a low voltage Halogen Lamp combined with a High Speed Lens Condensing System and a Field Iris Diaphragm. A Flip-In 1.0 Neutral Density Filter is built into the Illuminator, and 2" round or square filters may be inserted in the top of the Illuminator.

The Illuminators are equipped with an off-on switch, indicator lamp and a rheostat to control the intensity of the Halogen Lamp (Fig. 7-8). The Control Knob is numbered 1 to 12. Turning the knob to higher numbers increases intensity of the Lamp. For maximum lamp life, use the lowest number setting which permits comfortable viewing reserving the higher number settings for photomicrography.

Before using Illuminator. Align Lamp per Lamp Alignment and Replacement Instructions below to obtain maximum, even light from Illuminator.

LAMP ALIGNMENT & REPLACEMENT 20W HALOGEN

Use following procedure to adjust lamp position.

CAUTION

This Halogen Cycle Lamp is pressurized and may shatter. Do not operate lamp in excess of rated voltage as this will increase lamp pressure and the risk of shattering. Protect lamp against abrasions and scratches, and against liquids when lamp is operating.

To guard against personal injury, wear protective eye-glasses and clothing when handling lamp. Provide protective screen or shield with equipment in which lamp is installed or used. Turn power off when installing and before removing lamp. Dispose of lamp with care. Allow lamp to cool before removing. Always use the specified replacement lamp.

1. Remove socket assembly from rear of base by pulling on flange (Fig. 7-9).
 - a. On Model 31-32-06 it is necessary to remove the guard before the socket assembly is removed (Fig. 7-10).
2. After it has cooled remove the lamp by pulling it straight out of the ceramic socket.
3. Clean the Replacement Lamp, Cat. No. 31-31-81-01 or 31-31-81-10 (GE-788) of all fingerprints and dirt. Handle lamp with cotton gloves or tissue.
4. Insert lamp in socket, inserting the lamp pins into the ceramic socket openings.
5. Sight thru the two holes in the socket assembly (Fig. 7-10a). Move the lamp in or out of the lamp socket so the lamp filament is centered in sight holes as shown in Fig. 7-10b.

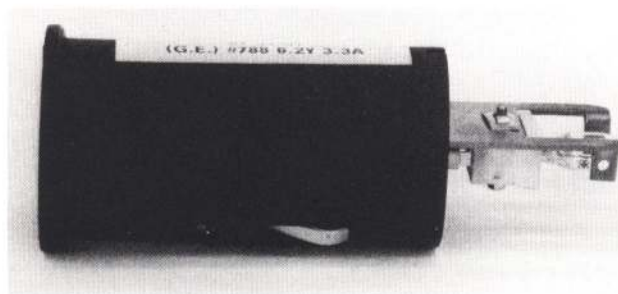

FIG. 7-9 - SOCKET ASS'Y

6. Center the lamp filament in space "A" as shown in Fig. 7-10c. When the lamp filament is centered, the two spaces "B" will be equal.
7. Recheck for fingerprints or dirt. Do not disturb alignment.
8. Replace socket assembly in base.

A final adjustment of lamp position must be made to insure maximum performance.

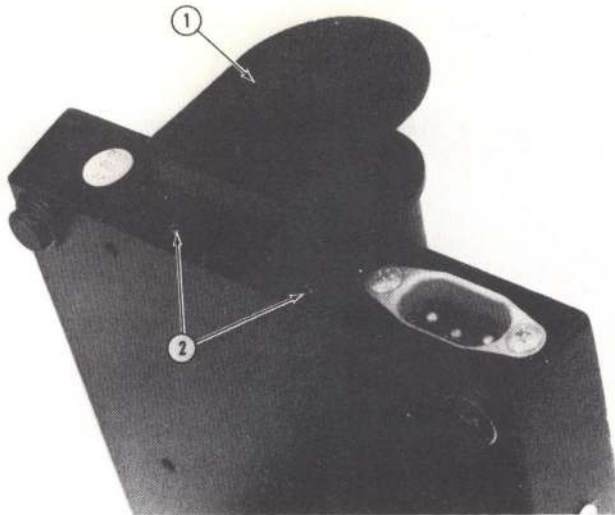

FIG. 7-10 -
1. Guard
2. Screws

Use the 10X Objective and the lowest power Eyepieces available to make this adjustment. Turn on the Illuminator and, looking in the Eyepieces, adjust the position of the lamp filament along the axis of motion (in and out) until the entire field of view is evenly illuminated. Satisfactory results will generally be obtained with all other Objectives by leaving the filament in the initial position. However, to obtain maximum performance for critical observation, it is recommended that the lamp filament position be adjusted for each individual Objective, adjusting the lamp to give the best balance between evenness and brightness.

Installation of Illuminators:

When ordered with a microscope, the illuminator is fastened in position within the base. When the illuminator is ordered as a separate item, it is necessary to install it on the Microscope as follows:

TO INSTALL A BASE ILLUMINATOR

High Intensity Illuminator - All Cat. Nos.

1. Install upper cover of illuminator in microscope base. It is secured with two screws and clips (Fig. 7-11).
2. Illuminators have a receptacle that accepts a plug from the Wire Harness - Cat. No. 31-32-93. See Section 9. If used, this should be installed next.
3. Clean and adjust lamp.
4. The Microscope Base has two dowel pins (Fig.7-11) to ensure alignment. Locate illuminator on pins and fasten in place with three screws using hex wrench (9/64 across flats).

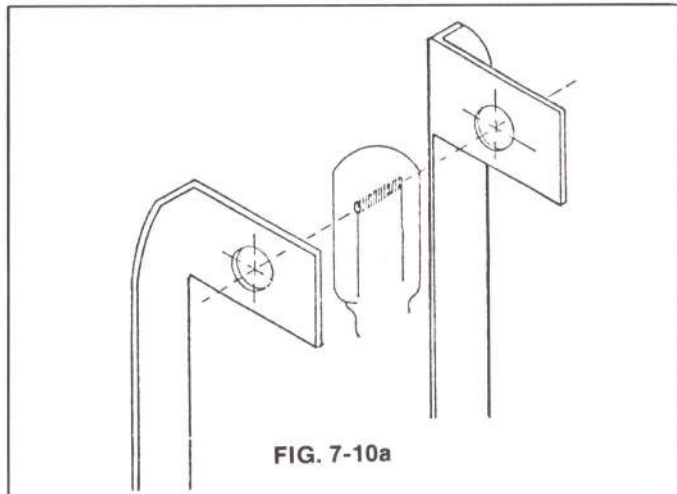

FIG. 7-10a

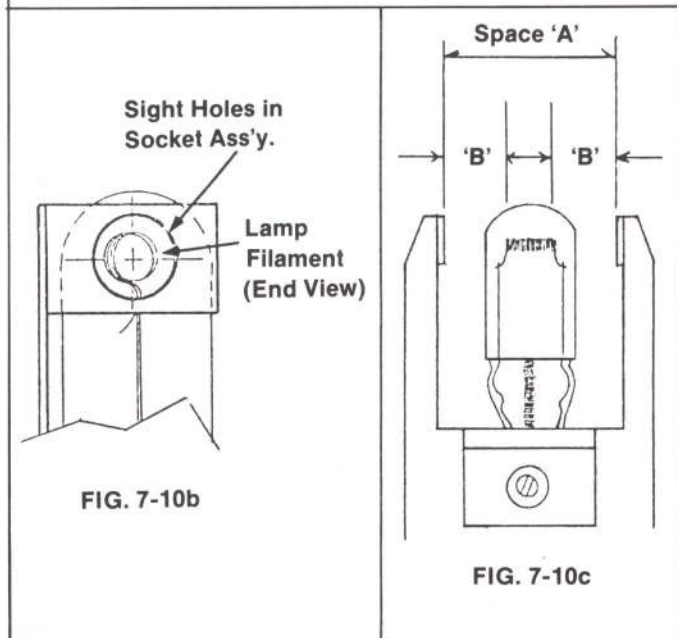

FIG. 7-10b

FIG. 7-10c

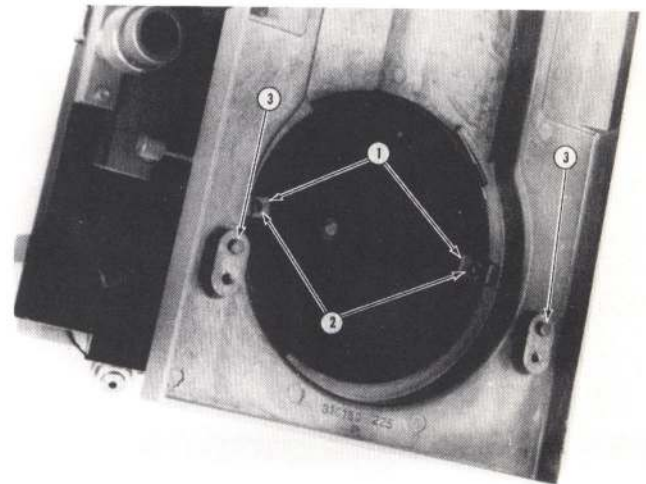

FIG. 7-11 - HIGH INTENSITY BASE ILLUMINATOR

1. Clamp
2. Screw
3. Locating Dowel

SECTION - 8 Nosepieces

FIVE-HOLE NOSEPIECE CAT. NO. 31-18-68

This Nosepiece is reversible on all Balplan Stands. This is accomplished by inserting the Hexagonal Wrench provided through the hole in the side of the Arm and loosening the set screw, Fig. 8-1, while supporting the Nosepiece with your other hand. The Nosepiece can then be removed from the Arm. It can be replaced by reversing the procedure if the desired position of the Objectives is toward the front. If the desired position of the Objectives is toward the back, a Nosepiece Adapter, Cat. No. 31-18-71, must first be installed on the Nosepiece. The Nosepiece should be inserted into the Adapter and the two held firmly together as the set screws in the Adapter are tightened, Fig. 8-1. This assembly is then held firmly upward into the Arm with the Objective holes toward the back and the set screw tightened.

NOTE

The Nosepiece should be held firmly upward during the tightening process to ensure proper shouldering.

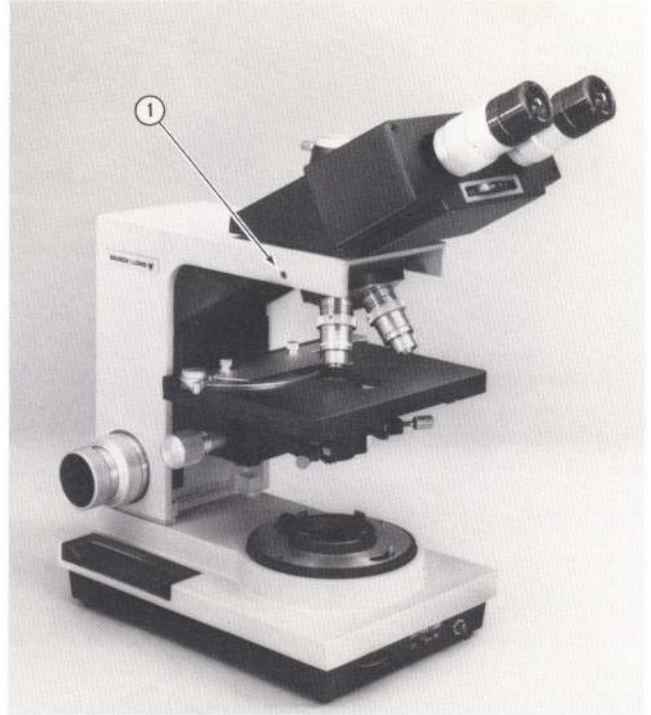
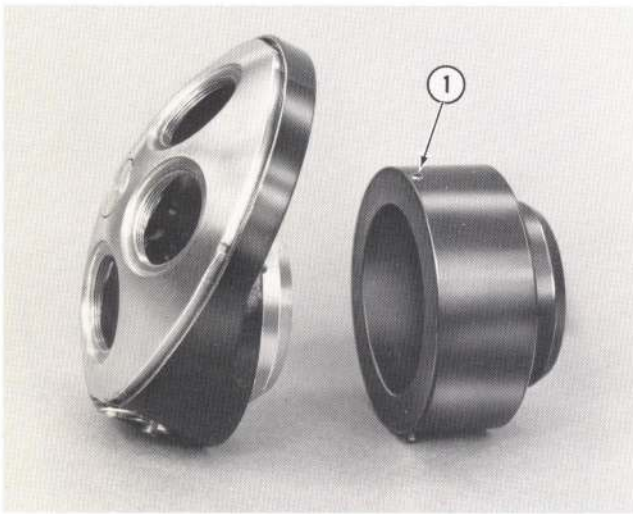

FIG. 8-1 - NOSEPIECE SET SCREW

1. Set Screw



**FIG. 8-2 - BALPLAN FIVE-HOLE NOSEPIECE AND
ADAPTER**

1. Adapter Set Screw

SECTION - 9 Viewing Adapters

The Cat. No. 31-18-93 Dual Viewing Adapter (Cat. No. 31-18-97 for use in Canada) and the Cat. No. 31-18-85 Multiple Viewing Adapter (Cat. No. 31-18-96 for use in Canada) are available for your Balplan Microscope for the purpose of dual and multiple viewing. Both Adapters fulfill that purpose but the Multiple Viewing Adapter was designed with a greater separation between the Viewing head positions and separate focusing for the observer station. The Multiple Viewing Adapter allows more flexibility in arranging comfortable positions for the operator and observer. The Viewing Adapters are attachable to your Stand as follows:

Remove the Head that is on the Stand by loosening the Knurled Clamp Screw, Fig. 9-1, and lift the Head. Place the Adapter, with its Knurled Clamp Screw screwed out, Figs. 9-2 and 9-3, over the collar on top of the Stand. Orient the Adapter to the desired position and tighten the Knurled Clamp Screw. A Support Leg is screwed into the bottom of the Multiple Viewing Adapter and the telescoping leg adjusted by loosening the Lock Ring, Fig. 9-4. Be sure to tighten the Lock Ring after adjustment is made.

When using the Dual Viewing Adapter, it is recommended that one of the 30° Heads (heads inclined at 30° from horizontal) be used at the operator's position and the 45° Head be used at the observer's position. This results in a comfortable eyepoint position for both observers.

When using the Multiple Viewing Adapter, it is recommended that both Heads be 30° Heads.

The Multiple Viewing Adapter has an adjustment which permits the observer to focus the image of the specimen by use of the Focusing Knob, Fig. 9-3. This should be done after the operator has completed focusing the microscope.

The Dual Viewing Adapter and the Multiple Viewing Adapter are equipped with a Pointer Projector which projects an illuminated arrow into the field of view. With both Adapters is a Wire Harness which replaces the back

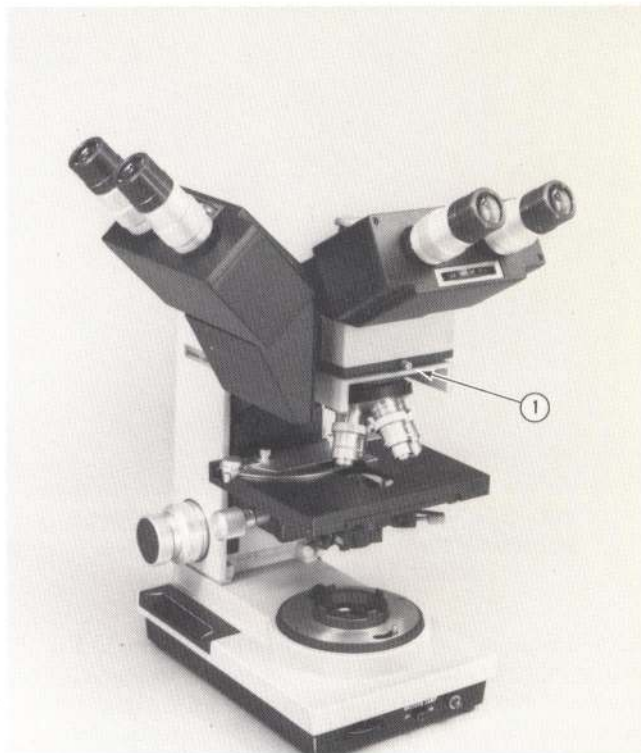

FIG. 9-2 - BALPLAN MICROSCOPE EQUIPPED WITH DUAL VIEWING ADAPTER

1. Double Head Clamp Screw

cover of the Microscope, Fig. 9-5. The Wire Harness has an electrical outlet into which the Pointer Projector may be connected. To install the Wire Harness, proceed as follows:

Disconnect the line cord from the power supply. Remove



FIG. 9-1 - BALPLAN PHOTOBINOCULAR HEAD

1. Knurled Clamp Screw
2. Eyepiece Tube Lock Screw
3. Eyepiece Tubes

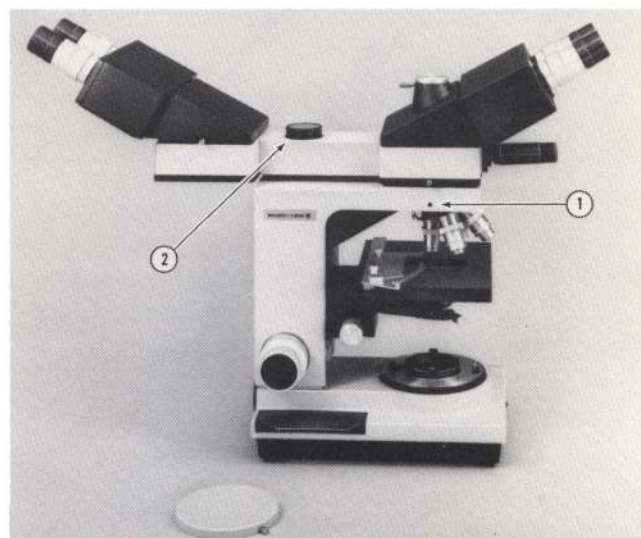

FIG. 9-3 - BALPLAN EQUIPPED WITH MULTIPLE VIEWING ADAPTER LENS SUPPORT LEG

1. Viewing Adapter Clamp Screw
2. Focusing Knob

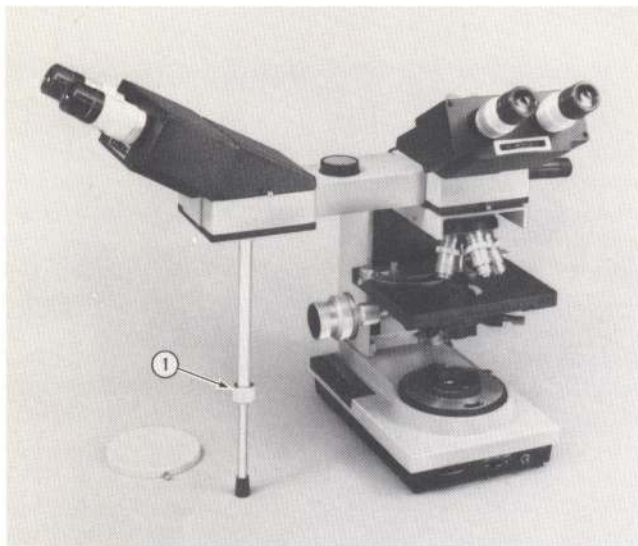

FIG. 9-4 - BALPLAN EQUIPPED WITH MULTIPLE VIEWING ADAPTER
1. Support Leg Lock Ring

the illuminator by removing the three screws, Fig. 9-6. Remove the four screws in the back cover. Replace the back cover with the Wire Harness, feeding the Cord down through the opening into the High Intensity Base Illuminator or the Professional Optilume, Fig. 9-8. Connect the Wire Harness cord to the receptacle in the Base as shown in Fig. 9-9. Replace the Illuminator.

When the Wire Harness has been installed, the cord from the Pointer Projector may be plugged into the receptacle located near the top of the Wire Harness. The Projector may be turned On or Off with the Switch shown in Fig. 9-7.

The Pointer Projector may be manipulated such that the illuminated arrow may be imaged at any point in the field of view. The amount of tension on the pointer motion may be adjusted by loosening or tightening one or more of the three screws, Fig. 9-7.

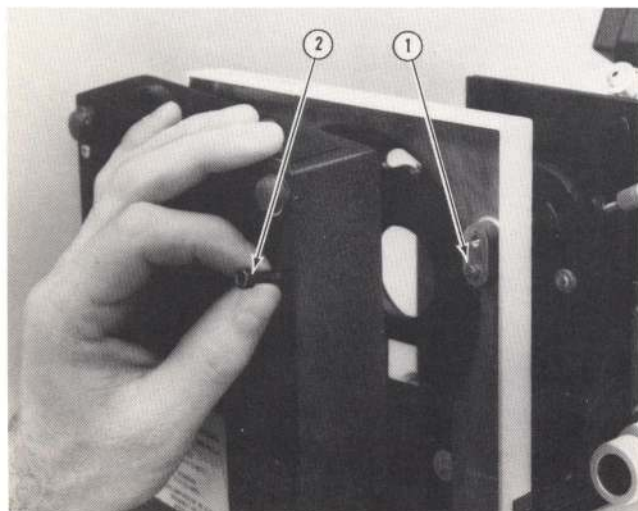

FIG. 9-6 - REMOVING THREE SCREWS IN BASE

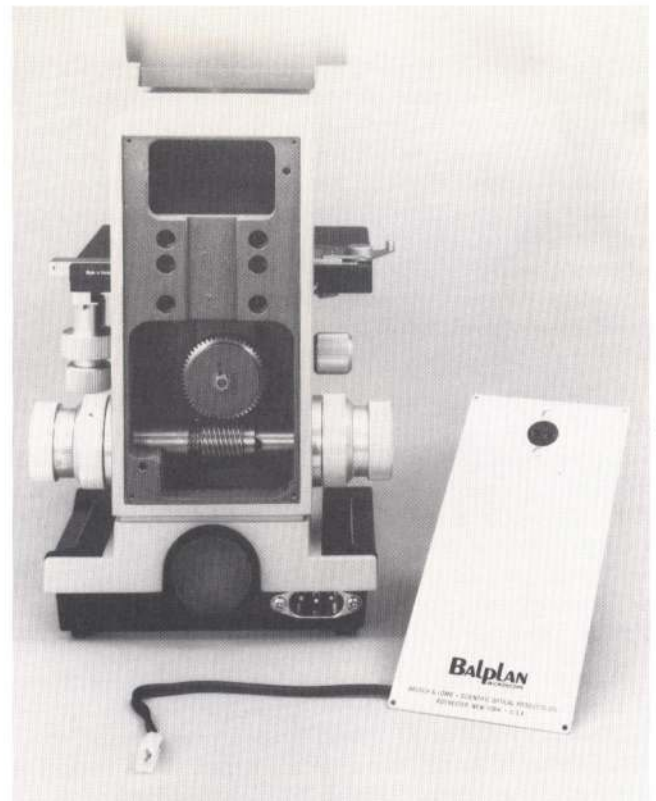

FIG. 9-5 - BALPLAN MICROSCOPE (WITH BACK COVER REMOVED) AND WIRE HARNESS

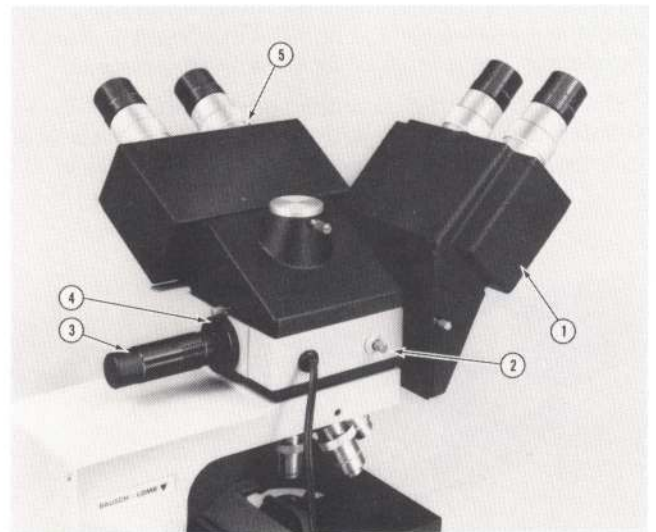
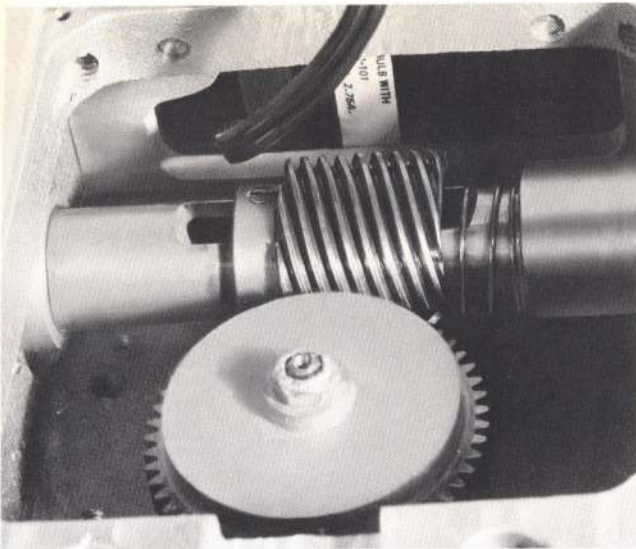

FIG. 9-7 - BALPLAN MICROSCOPE WITH TRIOCCULAR HEAD & 45° BINOCULAR HEAD
1. 45° Binocular Head
2. Pointer Projector Switch
3. Pointer Projector
4. Tension Adjusting Screws
5. Triocular Head



**FIG. 9-8 - INSTALLATION OF WIRE HARNESS
SHOWING CORD LEADING TO BASE
ILLUMINATOR**

If the image of the arrow is not in sharp focus because you are not wearing your corrective lenses, refer to Page 3-3.

To replace the lamp in the Dual Viewing Adapter, unscrew the end of the Pointer Projector (indicated by Reference Numeral 3 of Fig. 9-7). Remove the lamp by tipping Pointer Projector downward. Replace the lamp and reassemble.

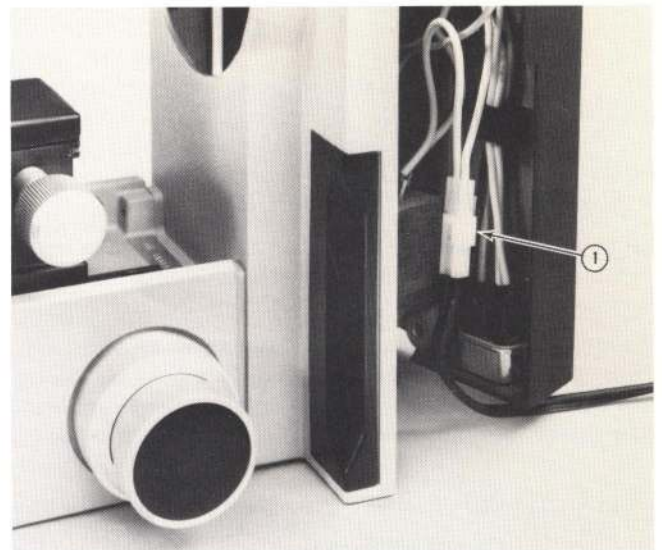

**FIG. 9-9 - HIGH INTENSITY BASE ILLUMINATOR
SHOWING CORD FROM WIRE HARNESS**

1. Wire Harness Cord

NOTE

Both Viewing Adapters may be purchased without the Pointer Projector - the Dual Viewing Adapter as Cat. No. 31-18-83 and the Multiple Viewing Adapter as Cat. No. 31-18-84.

By adding Viewing Adapters to the Balplan Microscope a multiple viewing conference microscope may be assembled. Three, five and seven observers may simultaneously view the same sample. (Figs. 9-10 & 9-11).

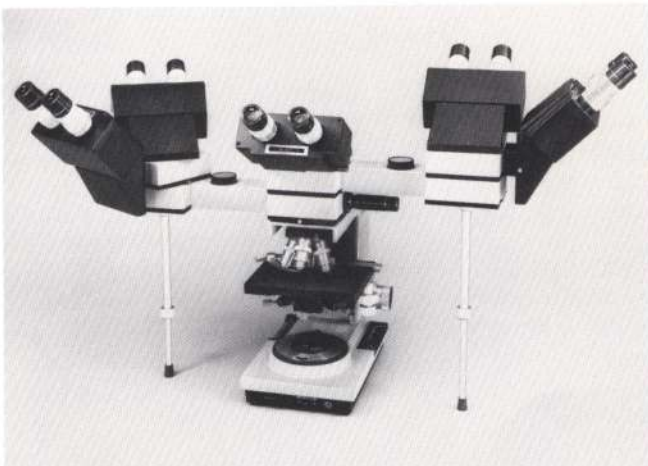

**FIG. 9-10 - BALPLAN MULTIPLE VIEWING
CONFERENCE MICROSCOPE**

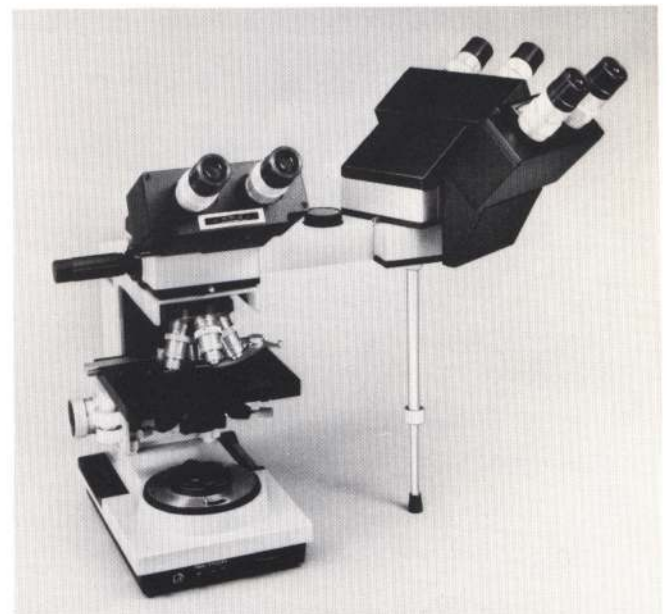

**FIG. 9-11 - BALPLAN MULTIPLE VIEWING
CONFERENCE MICROSCOPE**

SECTION - 10 Photomicrography

Three Cameras are available to make Photomicrography possible with your Balplan Microscope. Each Camera consists of a Camera Body, Focusing Tube with built-in Shutter and Camera Lens Coupler. The Focusing Tube is common to all three Cameras. Only the Camera Bodies differ.

Any one of the three Cameras can be used to make photomicrographs in black and white or color. They are classified by size and by the types of film they use.

This unit takes 4 x 5 film. It will accommodate any Film Holder or other accessory which will fit a 4 x 5 Graphic or Graflex Back. 4 x 5 sheet films and plates are available in a wide variety of emulsions in both black and white and in color.

A ground glass Focusing Screen is supplied with the unit.

The intermediate size Camera Body utilizes a POLAROID, Series 10, 3-1/4 x 4-1/4 Film Pack Back. POLAROID Film Packs in black and white and in color permit instant photomicrographs of suitable size for normal viewing. Included with this Camera is a Viewfinder Adapter Plate which permits the use of a Standard Eyepiece or a Viewfinder Eyepiece to help in parfocalizing the film plan image.

4 X 5 CAMERA (10X MAG.), CAT. NO. 42-12-47-28

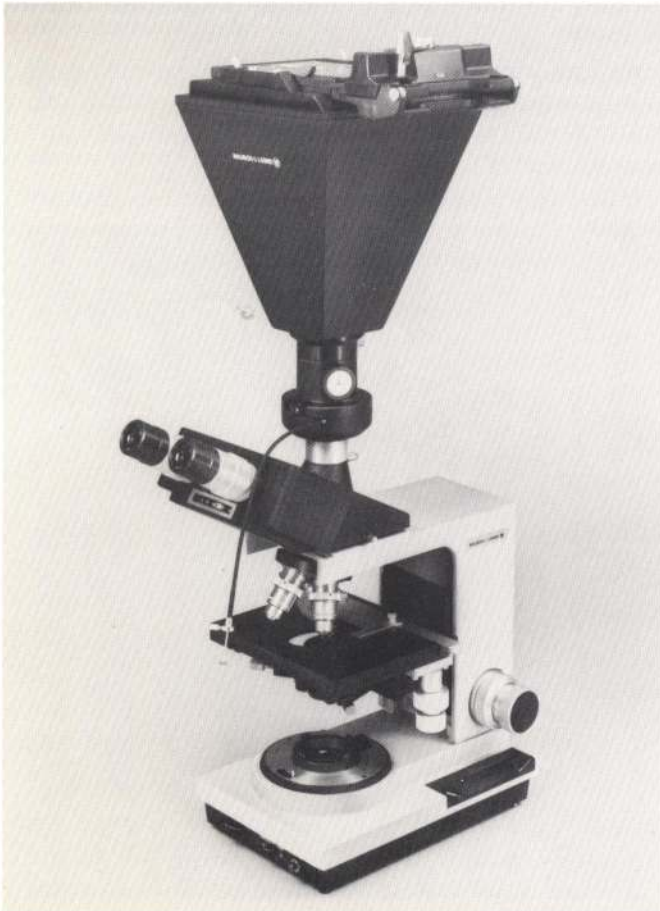

FIG. 10-1 - BALPLAN MICROSCOPE WITH 4 X 5 CAMERA

3-1/4 x 4-1/4 POLAROID CAMERA (7.5X MAG.), CAT. NO. 42-12-47-37

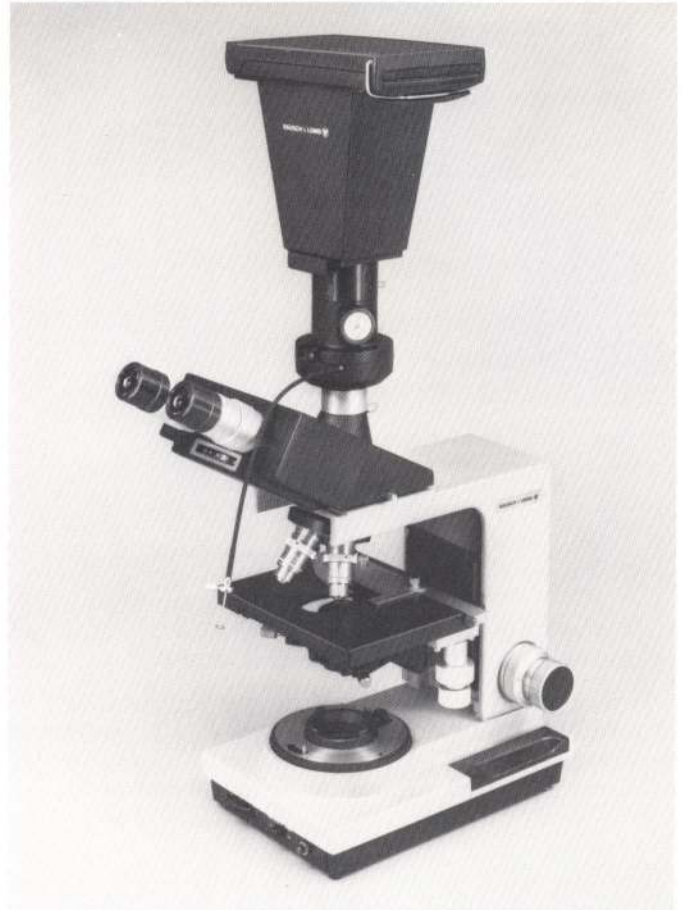

FIG. 10-2 - BALPLAN MICROSCOPE WITH 3-1/4 X 4-1/4 CAMERA

The 35mm Camera Body uses standard cartridges (cassettes) of the many emulsions offered in black and white or in color in this universally available size. The useful negative area is 24 x 36mm (about 1" x 1-1/2"). As with the 3-1/4 x 4-1/4 POLAROID® Camera Back, a Viewfinder Adapter Plate is furnished to aid in parfocalizing. 35mm film is especially suitable in situations where a large number of negatives are required or where color transparencies for projection are desired. In either case, compactness, rapidity of film transport and economy are important advantages.

FOCUSING TUBE WITH SHUTTER AND LENS COUPLER CAT. NO. 42-12-15-47

This Focusing Tube is designed to work with all three Camera Bodies. Select the magnification setting on the tube dial and the microscope and camera system should be parfocal.

Available also are the following accessories to aid you in your Photomicrography.

35mm CAMERA (3X or 5X MAG.),
CAT. NO. 42-12-47-30



FIG. 10-3 - BALPLAN MICROSCOPE WITH 35mm
CAMERA



FIG. 10-4 BALPLAN MICROSCOPE WITH 35mm
CAMERA AND AUTOMATIC EXPOSURE
CONTROLLER

EXPOSURE METER,
CAT. NO. 42-12-40

The Exposure Meter consists of a Light Sensor permanently connected to a Metering Unit by means of a flexible cord. The Metering Unit has been factory-calibrated to provide readings within the range of .02 to 100 foot-candles. A circular Exposure Computer is supplied to convert from meter reading to exposure setting relative to Film Speed and Camera Magnification being used.

The unit is designed principally to be used in conjunction with the Bausch & Lomb Integrated Camera Series II which has an accessory slot for insertion of the Sensor. However, an auxiliary Sensor Holder is available permitting usage of the Sensor either at the Microscope Eyepiece position or at a film plane location.

AX-1 AUTOMATIC EXPOSURE CONTROLLER
CAT. NO. 42-12-51 (120V)
CAT. NO. 42-12-52 (240V)

The AX-1 Automatic Exposure Controller solves both difficult and routine photomicrography problems rapidly and accurately. The sophisticated solid-state circuitry determines the correct exposure time and operates the camera shutter. Each camera kit contains the appropriate camera back, controller unit and focusing tube with shutter and lens coupler.

10X VIEWFINDER EYEPIECE
CAT. NO. 42-12-02

This Eyepiece offers great convenience in framing the image area to be photographed through a Microscope. In the center of its field is a crossline to aid in centering the image area. Three rectangular frames are visible in the Eyepiece. One frame represents the areas covered by the 3-1/4 x 4-1/4 and the 4 x 5 Cameras. The other two frames represent the areas covered by the 35mm - 3X and the 35mm - 5X Cameras. Each frame is identified as such.

GROUND GLASS FOCUSING
SCREEN WITH CLEAR AREAS,
CAT. NO. 42-12-33

This Focusing Screen is a fine-ground Glass Screen with a clear center and clear rectangular area along each diagonal. The clear areas allow the operator to observe the image directly with a magnifier in a more critical focus.

4 X 5 FILM HOLDER
CAT. NO. 42-16-20

Polaroid No. 545 4" x 5" Film Holder accepts a wide variety of color and black & white sheet films.

Cat. No. 42-12-57-28	4" x 5" Camera Kit AX-1 (120V)
42-12-57-37	Polaroid 3/4 x 4/4 Camera Kit AX-1 (120V)
42-12-57-30	35mm Camera Kit AX-1 (120V)
42-12-57-38	4" x 5" Camera Kit AX-1 (240V)
42-12-57-47	Polaroid 3/4 x 4/4 Camera Kit AX-1 (240V)
42-12-57-40	35mm Camera Kit AX-1 (240V)

SECTION - 11

Filters

Colored filters are useful in controlling the contrast in an image, where various contrasting colors are present in the specimen. If, for example, a specimen has faint red and blues areas, a red filter will make the blue areas dark and the red areas light. Conversely, a blue filter will reverse this contrast pattern.

To reduce light intensity, neutral density filters are available. These come in various densities and sizes. The High Intensity Base Illuminator and the Professional Optilume have provision for the use of 2" round or square filters. The High Intensity Base Illuminator is equipped with a Flip-In 1.0 N.D. Filter.

Two color-balancing filters are available for use in Photomicrography. Cat. No. 31-35-86 is for use when using Daylight Type Color Film. Cat. No. 31-35-87 is for use with Tungsten Type Film. Cat. No. 31-35-91 is for use with Polaroid Color Type 668.

Neutral Density Filters

31-34-30	0.3 N.D. (2" Sq.)
31-34-31	0.6 N.D. (2" Sq.)
31-34-32	1.2 N.D. (2" Sq.)
31-34-35	0.9 N.D. (2" Sq.)
31-34-73	0.7 N.D. (2" Rd.)
31-34-75	1.3 N.D. (2" Rd.)

Color Balancing Filters

31-34-71	Blue - For High Intensity Illuminator
31-35-61	Green - For Phase Contrast
31-35-86	For Daylight Film
31-35-87	For Tungsten Film
31-35-91	For Polaroid Polar color II (Type 668)
31-35-93	Yellow

SECTION - 12

Phase Contrast Microscope Accessories

INTRODUCTION

Unstained colorless transparent microscope specimens frequently lack contrast when viewed under standard bright field illumination. Previously, time-consuming preparation methods were necessary which resulted in harmful physical or chemical changes that would destroy structural detail in the specimen.

Phase Contrast Microscopy overcomes this difficulty and permits the examination of living material without resorting to staining. This method can also be used with fixed and dry specimens including microtome sections. Even the selective differentiation of structure in fixed specimens is possible without staining, if mounting media of the correct index are used.

DESCRIPTION

Bausch & Lomb Phase Contrast accessory equipment is available in two types as follows:

1. The Phase Contrast Turret Condenser, with four Annular Stops and one Open Aperture with two interchangeable upper elements, one a 1.30 N.A. Hemisphere and the other a Medium Working Distance Lens (.70 N.A.). It includes a

Green Filter, up to four Planachromat Phase Contrast Objectives (10X, 20X, 40X, 100X) and a bottle of Immersion Oil.

2. The Long Working Distance (LWD) Phase Condenser and Iris Diaphragm for use with Planachromatic Phase Contrast Objectives (10X, 20X, 40X, 100X), Annular Stops corresponding to the Phase Objectives ordered, and a bottle of Immersion Oil, Fig. 12-2.

The Objectives are supplied in clear plastic screw-top containers for protection. A case is available for the storage of your Phase Contrast Accessory Kit. The case is of the same design for both Kits. A diagram of the interior of the case with part locations labeled for each of the possible Kit combinations described above is given in Fig. 12-3.

TURRET TYPE PHASE CONTRAST CONDENSER

To install the Turret-Type Phase Contrast Condenser on the Substage:

1. Raise the Specimen Stage to its highest position, then lower the Substage to its lowest position.

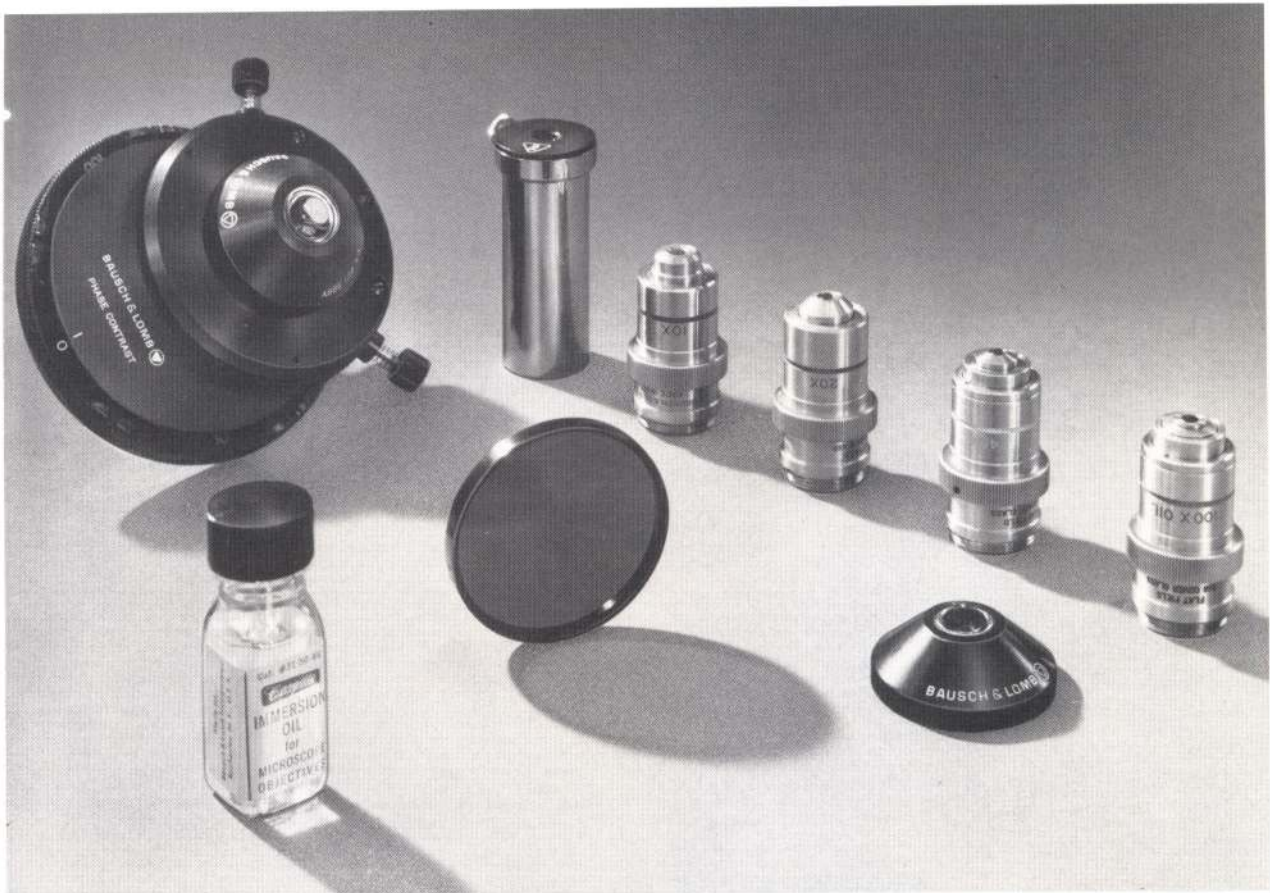

FIG. 12-1 - BALPLAN PHASE CONTRAST EQUIPMENT WITH TURRET CONDENSER

SECTION 12. FILTERS

2. Remove the Condenser presently in the Microscope by pulling straight out.
3. The Phase Contrast Condenser will snap in place by pushing the Key on the Condenser into the spring-loaded plunger in the Substage, Fig. 12-4.
4. Reset the Substage Focusing Stop as follows:

Each Rack and Pinion Substage has an easily adjustable Focusing Stop, Fig. 12-8.

This feature is most advantageous when various types of Condensers are to be used on the Microscope. The Focusing Stop should be set so that the Condenser never rises above the Stage surface or contacts the specimen slide. To adjust the Stop, loosen the Focusing Stop Lock Screw, Fig. 12-8, slightly with the Hexagonal Wrench provided. Position the Condenser at the desired maximum height and retighten the Lock Screw. Each Rack and Pinion Substage also has a Down Stop, Fig. 12-9, to prevent interference of various Condensers and Illuminators. To adjust the Stop, loosen the Stop Lock Screw, Fig. 12-9, with the wrench provided. Position the Condenser at the lowest position desired and retighten the Lock Screw.

5. The Medium Working Distance Lens, 0.70 N.A. may be substituted for the Abbe 1.30 N.A. Lens on the top of the Turret Condenser by racking the Substage down, unscrewing the lens in use and replacing it with the other lens. Handle

both lenses carefully to avoid scratching, and make sure that the replacement lens is screwed down tightly.

The standard lens may be used with specimen slides up to 1.3mm thick. The Medium Working Distance Lens has a working distance of 3.7mm in air (5.6mm in glass) and is ideally suited for blood cell counting chamber work.

ALIGNMENT AND OPERATION USING THE TURRET TYPE CONDENSER

The Microscope is set up for Phase Contrast operation by removing the regular Objectives from the Nosepiece and replacing them with the Planachromat Phase Contrast Objectives. Make sure that the Iris Diaphragm on the Phase Turret Condenser is completely open. Rotate the Turret, Fig. 12-5, until the figure "0" appears opposite the index line. Focus on a stained specimen. If it becomes necessary to reduce the intensity of the illumination for better observation, do so by inserting a neutral density filter in the Illuminator. The green filter may also be used if desired. If the Microscope is equipped with the High Intensity Base Illuminator, the Field Diaphragm should be centered as described in Section - 2, under Field Illumination Control. Now rotate the Turret until the number corresponding to the Objective in use appears in the index window. Do not use the Iris Diaphragm to control the illumination level after the proper Condenser Annular Ring or Stop has been selected and adjusted for use.



FIG. 12-2 - BALPLAN PHASE CONTRAST EQUIPMENT WITH L.W.D. CONDENSER

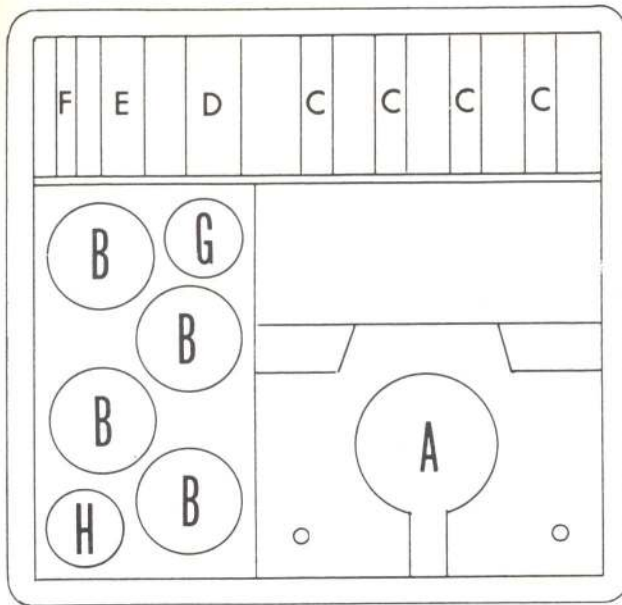

**FIG. 12-3 - PART LOCATION IN CARRYING CASE
PHASE CONTRAST ACCESSORIES**

Location	Cat. No.	Description
A	31-55-31	Turret Phase Condenser
	31-55-32	LWD Phase Condenser
B	31-12-40, -41, -42, -43	Phase Objective, 10X, 20X, 40X, 100X
C	31-58-63, -64, -65, -66	Annular Stop For LWD Condenser, 10X, 20X, 40X, 100X
D	315843-901	1.30NA Hemisphere For Turret Phase Condenser
E	315843-902	.70NA, Medium Working Distance Lens For Turret Phase Condenser
F	31-55-61	Filter, Green
G	31-50-78	Eyepiece Telescope
H	31-50-86	Immersion Oil

CENTERING THE ANNULAR DIAPHRAGM

If the Microscope is equipped with a Bertrand Lens Attachment, Cat. No. 31-57-85, move the Bertrand Lens into viewing position. Focus on Annular Rings, using Bertrand Lens Focusing Knob. In the absence of a Bertrand Lens, replace the Microscope Eyepiece with the Auxiliary Eyepiece Telescope. Focus on the darker ring pattern appearing in the field of view. This is done by loosening the clamp screw on the Eyepiece Telescope and then tightening the clamp screw. Make sure that the Telescope is resting with its positioning ring firmly against the Microscope Eyepiece shoulder. The brightly illuminated image of the Condenser Annular Ring



**FIG. 12-4 - INSTALLING CONDENSER INTO
SUBSTAGE**

1. Key
2. Spring Loaded Plunger

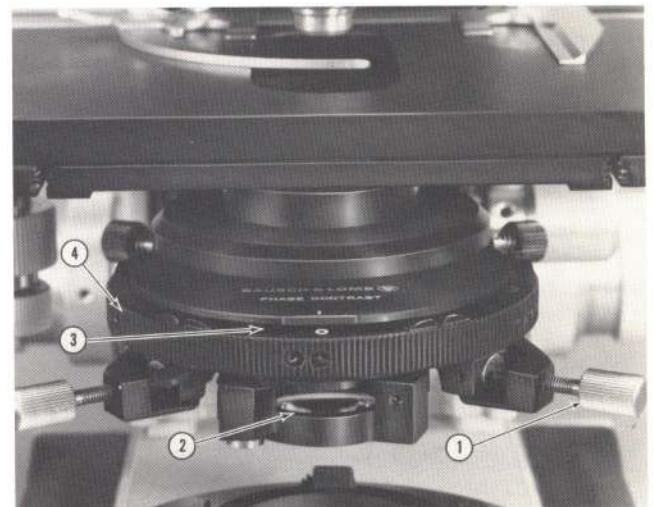

**FIG. 12-5 - BALPLAN PHASE CONTRAST
EQUIPMENT (TURRET TYPE)**

1. Centering Keys
2. Flip-In Lens
3. Index Window
4. Turret
5. Centering Keys

and the retardation annulus in the Objective will appear in the field of view of the Eyepiece Telescope. The bright image must now be adjusted so that it lies completely within the darker ring. This is done by means of two centering screws located within the Condenser Turret Assembly.

Push in on the Centering Keys, Fig. 12-5, and turn the Keys alternately while observing the movement of the bright ring until it is concentric with and completely covered by the darker ring. Fig. 12-6 shows the overlapping annular patterns when they are in the typical "non-centered" positions.

The retardation annulus is intentionally made slightly broader than the image of the Annular Diaphragm to ensure that the latter is completely covered, which prevents leakage

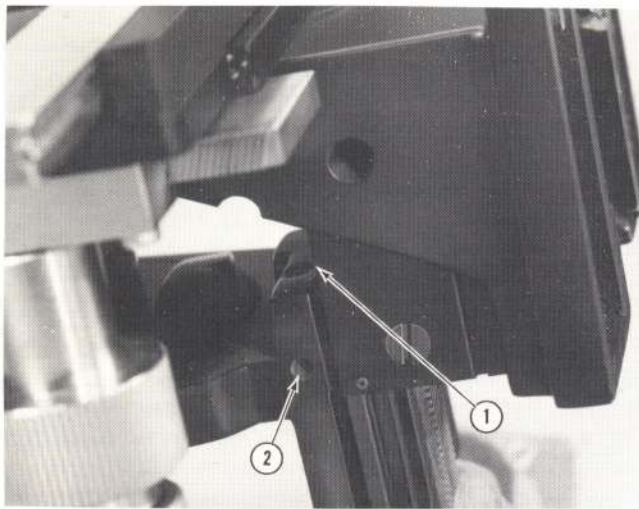

FIG. 12-8 1. Substage Up Stop
2. Substage Up Stop Lock Screw

n , and a thickness t , is given by nt , regions of equal thickness having a higher refractive index will appear darker than equally thick regions of lower refractive index. Regions of equal refractive index, but having greater thicknesses, will likewise be darker than those having equal refractive index, but of less thickness.

USE OF FILTERS

The Phase Contrast Objectives introduce one-quarter wavelength of light phase shift when using green light. The use of other colored filters, although not restricted, will normally result in a departure from this amount of shift. In a few cases, where the object has undergone light selective staining, for example, the use of proper color filters may prove of some advantage in enhancing contrast.

Use of white light is also permissible. When using white light one can expect some loss of image crispness and slight coloration effects which are characteristic of the objectives, light source, specimen structure and mounting.

USE OF OIL WITH CONDENSER

The Condenser can be used "dry" for all phase observations. Since the requirements on the numerical aperture to be filled for any of the Phase Contrast Objective never exceed 1.00 N.A., including the Oil Immersion Objective, there is no advantage to be gained through the use of oil with the Condenser.

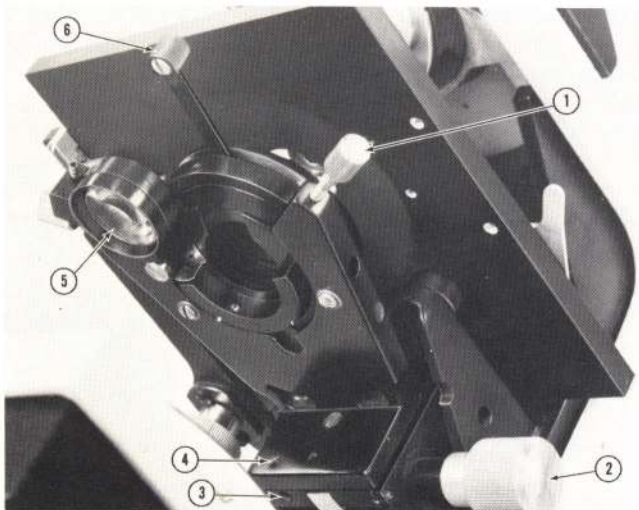

FIG. 12-9 - BALPLAN SUBSTAGE
1. Substage Centering Screws
2. Substage Focusing Knob
3. Substage Down Stop
4. Down Stop Lock Screw
5. Flip-In Lens
6. Iris Diaphragm Control

SECTION - 13

Polarized Light Microscopy

Polarized light is made available for the qualitative examination of crystals, fibers, minerals, etc. with the use of the Polarizer, Cat. No. 31-57-77. This Polarizer fits in the filter recess of the High Intensity Base Illuminator and the Professional Optilume.

Two types of Analyzers are available. An Eyecap Analyzer, Cat. No. 31-57-84, may be used over the Eyepiece, or an Analyzer Slide, Cat. No. 31-57-86, may be used in conjunction with the Slide Attachment, Cat. No. 31-57-92, Fig. 13-2.

The Eyecap Analyzer and Polarizer combine to form an economical means of providing Polarized Light Microscopy. They are best suited to elementary work and highly birefringent specimens, which give a high contrast in polarized light.

In the fabrication of the optics a slight amount of residual strain may result. This amount of strain will not affect the image quality in other types of microscopy. The effect in Polarized Light Microscopy may be a lowering of the contrast in comparison to that of Polarizing Microscopes using strain-free optics. The amount of residual strain may be lessened by using fewer optics between the Polarizer and Analyzer. For this reason it is recommended that the Analyzer Slide be used thus eliminating the effect of the optics in the Microscope Head. If the specimen is highly birefringent, the effect of this strain will be of no consequence.

The Analyzer Slide and Slide Attachment may be installed on your Balplan Microscope as follows:

Remove the Head from the Stand. Loosen the Clamp Screw, Fig. 13-2, on the Slide Attachment and place the Attachment on the Stand with the Clamp Screw to the right side of the Stand. Square the Attachment to the top of the Stand and tighten with the Clamp Screw, Fig. 13-1. When in this orientation, the vibration axis of the Analyzer will be parallel to the long dimension of the Microscope Arm.

The Analyzer Slide has the letter "A" engraved on one side of the slide, Fig. 13-2. In the opposite side of the slide are two slots that are part of the detent mechanism. The slide must be inserted in the slot of the Slide Attachment, with the letter "A" facing you, in order for the detents to function. When the Analyzer is in the correct detent position for Polarized Light Microscopy, the letter "A" will be visible. In the other detent position, the letter "A" is not visible.

The Eyecap Analyzer has an index line which represents the axis of vibration. When it is installed over the Eyepiece, it should be oriented either perpendicular or parallel to an imaginary line connecting the centers of the Eyepieces.

The Polarizer must be oriented so that its transmission axis is perpendicular to the axis of the Analyzer. The index line on the Polarizer is parallel to the Polarizer's axis.

With the Analyzer installed as directed, place the Polarizer in the filter recess or over the lens of Illuminator. While observing through the Eyepiece, rotate the Polarizer until extinction (minimum brightness) occurs.

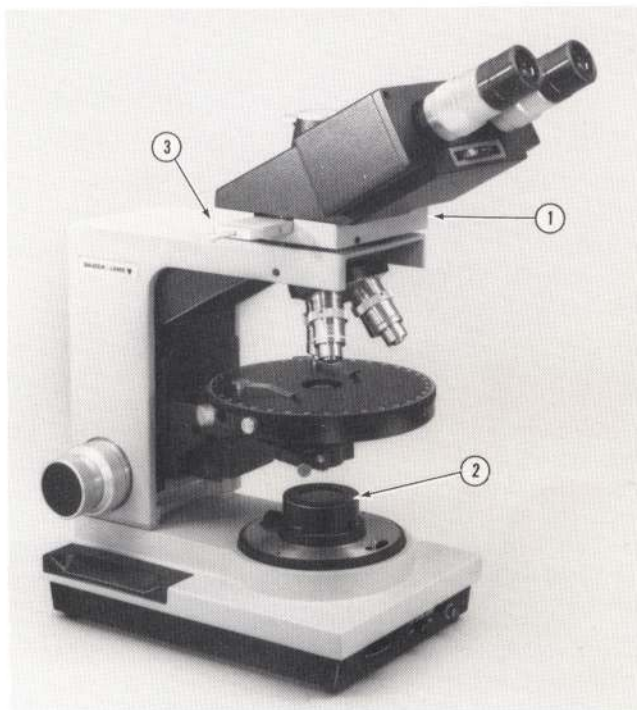

FIG. 13-1 - BALPLAN MICROSCOPE WITH POLARIZER & ANALYZER

1. Slide Attachment
2. Polarizer
3. Analyzer Slide

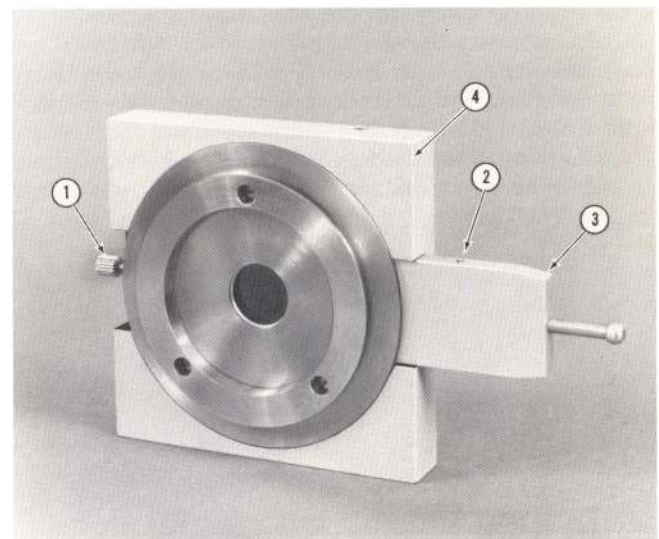

FIG. 13-2 - BALPLAN SLIDE ATTACHMENT & ANALYZER SLIDE

1. Clamp Screw
2. Letter "A"
3. Analyzer Slide
4. Slide Attachment

SECTION - 14

Dark Field Microscopy

Various means have been developed for accomplishing Dark Field Illumination. The device used generally consists of a special Condenser for the Substage of the Microscope replacing the Condenser employed for Bright Field Illumination. It is usually used in conjunction with a conventional Microscope Illuminator and provides a hollow, annular cone of light. The apex of the cone is formed at the object plane.

In the Balplan Microscope, Dark Field Illumination is achieved with the Paraboloid Condenser, Cat. No. 31-55-33.

Successful Dark Field Illumination requires a light source of high intensity. Sky light and the light provided by frosted lamps of the common variety are inadequate. The Balplan High Intensity Base Illuminator provides ample illumination for dark field use with the Paraboloid Condenser and has the advantage of being a built-in aligned unit.

DARK FIELD ILLUMINATION WITH THE PARABOLOID CONDENSER, CAT. NO. 31-55-33

Paraboloid Condensers are primarily designed to be used with a medium to high power Objective.

The principle of the Paraboloid Condenser is illustrated in Fig. 14-2. Parallel light passes around the opaque central stop, is reflected at the parabolic surface, and exits through the upper plano surface into the object slide. For optimum results (achieving maximum contrast between object detail and background) the object plane must coincide with the point of focus of the Paraboloid Condenser. Light passes through this point under angles equal to numerical aperture limits of 1.20 to 1.37. Since the N.A. limits are greater than 1.00, it is always necessary to maintain oil contact between the Condenser and object slide. Furthermore, to realize the dark field image, it becomes necessary to use an Objective with an N.A. of less than 1.24. This necessitates the 100X 1.25 N.A. Objective be used with a Funnel Stop. A Funnel Stop is a fixed Diaphragm designed to reduce the N.A. of an Objective. A special wrench is supplied with the Funnel Stop to aid

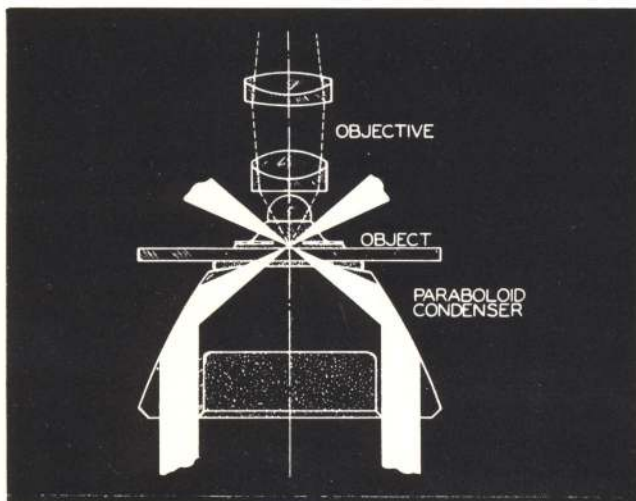

FIG. 14-2 - PARABOLOID CONDENSER



FIG. 14-1 - BALPLAN CARDIoid & PARABOLOID CONDENSERS

in its installation. The two prongs of the wrench fit the slots in the Diaphragm at the top (Nosepiece end) of the Objective. Unscrew the Diaphragm from the Objective, turning the wrench counterclockwise as for a normal screw thread. Replace the Diaphragm with the Funnel Stop, using the wrench to tighten it into place. When returning to bright field use of the Objective, remove the Funnel Stop and replace it with the standard Diaphragm.

A word of caution - the top lens is somewhat exposed when the Diaphragms are removed. Care should be exercised to avoid touching this surface.

A 100X Objective having an Iris Diaphragm is also available. This eliminates the need for placing a Dark Field Stop in the Objective and allows easier interchanging between Dark Field and Bright Field Microscope, Cat. No. 31-12-27-02.

MOUNTING CONDENSERS

To mount the Paraboloid Condenser to the Substage, rack the Substage down. The Condenser will snap in place by pushing the Key on the Condenser into the spring-loaded plunger in the back of the Substage.

The Body of this Condenser is threaded and is provided with a lock ring, so that its height in the Substage may be adjusted and the Condenser locked in place. If the Substage ttStop was previously set for Bright Field Illumination, rack the Substage up to its highest position and adjust the Condenser vertically by screwing the threaded portion up or down until the top of the Condenser is just below the top of the Microscope Stage. Then, lock it in place by means of the lock ring. This will allow you to interchange Bright Field and Dark Field Condensers without adjustment of the Substage stops.

Two Substage Centering Screws are supplied with the Dark Field Condensers, Fig. 14-4. If your Substage is not already equipped with Centering Screws, Cat. No. 313214-198, the Set Screws, Fig. 14-4, should be replaced with the Centering Screws supplied with the Condenser. Use the Hexagonal Wrench supplied to remove the Set Screws.

By means of the two Centering Screws, adjust the Condenser until its top is centered in the Stage opening. Select a specimen slide no thicker than 1.35mm. Make sure that the slide is clean. Mount the material to be examined on it and cover it with a #1-½ Cover Glass. Place a generous drop of oil on the Condenser and lower it slightly below the surface of the Microscope Stage by racking the Substage down. Place the slide on the Stage and rack the Condenser up until oil contact with the slide is made.

Use a 10X Objective and focus on the specimen. Focus the Condenser up and down by means of the Substage Rack and Pinion until the smallest spot of light is seen in the field. If your Illuminator has an Iris Diaphragm, open the Diaphragm completely. Make final centering adjustments of the Condenser by means of the Centering Screws, Fig. 14-3.

Having completed the above adjustments, all that remains in order to proceed with dark field observations is to substitute the desired high power Objective for the 10X Objective used for centering purposes.

OBJECT SLIDES AND COVER GLASS FOR DARK FIELD MICROSCOPY

Slides for use with the Dark Field Condensers must be no thicker than 1.35mm. Thinner slides are more desirable since some focal adjustment of the Condenser is permitted. Slides thinner than 1.0mm may, however, cause trouble through difficulty in maintaining adequate oil contact be-

tween the Condenser and the slide. Specimen slides vary in thickness in any one box. One should select slides by actually measuring them with a micrometer caliper. The cover glass should also be carefully measured if it is intended to use a "high dry" Objective. The cover glass for such an Objective should be selected for 0.18 ± 0.05 mm thickness. The cover glass thickness is of less importance when an oil immersion Objective is employed. However, the maximum thickness that can be readily accommodated with a oil immersion Objective is about 0.2mm.

Slides and cover glasses must be scrupulously clean and free from pits, scratches and similar defects. It is best to measure and select a number of slides and cover glasses at one time and reserve them for dark field work. Slides of optical quality fused quartz, ground and polished to the desired thickness, are available and are recommended for use. This is particularly important for ultramicroscopy with the Cardioid Condenser.

SPECIMEN PREPARATION

CAUTION

Do not put a thick or highly concentrated suspension on the slide. Be sure not to have too much solid material in the preparation. Best dark field results will be obtained from mounts which will appear void to the unaided eye.

Place a drop of the solution to be examined on the slide, cover with a cover glass and blot off any excess liquid with absorbent cotton, filter or blotting paper.

OBJECTIVES FOR DARK FIELD

The best results are obtained when using a Paraboloid Condenser if the N.A. of the Objective is not more than 1.0. The Balplan 10X, 0.25 N.A.; 20X, 0.50 N.A.; and 40X, 0.65 N.A. Objectives are suitable. If higher magnification is required, the Balplan 100X, 1.25 N.A. Objective should be employed, along with its appropriate Funnel Stop, Cat. No. 31-51-71.

Be sure the Objective does not have old immersion oil on the tip. Clean it carefully. Place a drop of oil on the cover slip, taking care to prevent the formation of bubbles. Cargille's Immersion Oil is recommended. It can be readily wiped off an Objective or slide with lens tissue and a very little solvent such as toluol or xylene. It is better than cedarwood oil in this respect and is, in addition, non-drying, non-fluorescing, colorless and has the proper refractive index for glass.

Raise the Stage until the oil drop contacts the tip of the Objective. Look into the Eyepiece(s) and carefully focus the Microscope using the fine adjustment until the specimen preparation is seen clearly.

If brilliantly-illuminated circles are observed, the cause may be air bubbles in the preparation, in the oil below the slide, or in the oil above the slide. When focusing any instrument used with immersion oil, always turn the Fine Adjusting Knob slowly to avoid drawing bubbles into the oil.

After use, wipe the oil off the Condenser and Objective with cotton or lens tissue.

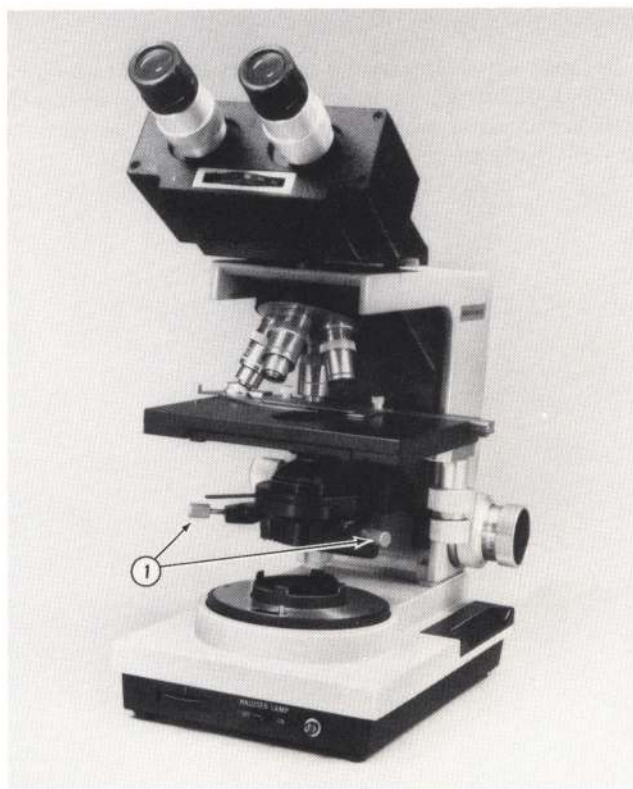

FIG. 14-3 - BALPLAN MICROSCOPE WITH HIGH INTENSITY BASE ILLUMINATOR AND TRIOCCULAR TUBE

1. Substage Centering Screws

SECTION - 15

Measuring With The Microscope

Eyepieces fitted with Micrometer Disc (Micrometer Eyepieces) are used for measuring the linear dimensions of microscopic objects. Micrometer Discs are scales on glass plates which fit into standard Eyepieces. They can be purchased separately or already installed in the Balplan Eyepiece. To install a Reticle in a non-focusable Eyepiece, unscrew the Diaphragm, place the Reticle on the Diaphragm with pattern side down and crimp the edge of the mount in about four places to hold the Reticle in place. Screw the Diaphragm into the Eyepiece until the Reticle is in sharp focus. To install a Reticle in the Focusable Eyepiece, Cat. No. 31-15-67, unscrew the focusable eye lens, drop the Reticle onto Diaphragm and install spring ring on top of the Reticle to make secure. Replace Eyepiece lens and focus on Reticle.

Before measurements can be made with any Eyepiece Micrometer Disc, it must be calibrated for the particular Objective, Eyepiece, and tube length employed.

This consists of determining the magnification factor, or the value of a division on the Eyepiece scale for a known dimension in the specimen plane. For this purpose, a Stage Micrometer is required. This is usually a glass slide carrying a scale of known intervals.

Two methods for calibration are presented below.

MAGNIFICATION FACTOR METHOD

When both Stage Micrometer and Eyepiece Micrometer are graduated in the same system, it is very easy to determine the number of times an object is magnified by the Objective and Field Lens of the Eyepiece when focused in the plane of the Eyepiece Micrometer Disc. Therefore, the size of any object as shown on the Eyepiece scale will be that dimension divided by the magnification factor. To determine the magnification factor, divide the dimension subtended in the

Eyepiece scale by the actual dimension on the Stage Micrometer scale included. Thus, if 0.1mm on the Stage covers 1.86mm on the Eyepiece scale, the magnification factor is $1.86 \div 0.1 = 18.6$. If an object subtends 0.25mm in the Eyepiece, its actual size is $0.25 \text{mm} \div 18.6 = 0.0134 \text{mm}$.

EYEPIECE SCALE VALUE METHOD

If the value of the Eyepiece Micrometer scale is not known, simply determine the number of divisions in the Eyepiece scale subtended by a known value on the Stage Micrometer when in focus.

To determine the value of one Eyepiece scale division, simply divide the value of the Stage Micrometer division by the number of Eyepiece scale divisions which it subtends in the image.

For example, 0.1mm on the Stage Micrometer scale covers 18.6 divisions on the Eyepiece scale. Therefore, one division of the Eyepiece scale equals $0.1 \text{mm} \div 18.6$ or 0.00537mm . The size of an object subtending 2.5 divisions in the Eyepiece will be $3.5 \times 0.00537 = 0.0134 \text{mm}$.

In calibrating the instrument and in making measurements, it is important that the object and the Eyepiece Micrometer scale appear to lie exactly in the same plane. Move your head slightly from side to side and observe the apparent motion of the image relative to the Eyepiece scale. When the image is focused in the plane of the Eyepiece scale, no relative motion will be seen.

Because your Microscope may have a small amount of residual distortion, it is a good practice, when making precision measurements, to calibrate the Micrometer Scale for only that portion of the scale being used.

SECTION - 16 Care Of The Microscope

The primary rule to follow with respect to proper care of the Microscope is to keep it as free from dust and dirt as is possible. Dusty lenses will result in foggy images. A fingerprint or a smear, on the other hand, will degrade the image badly, giving a milky, washed-out appearance. When not in use, cover the Microscope with the plastic cover which is supplied with it.

CLEANING OF OPTICS

The experienced microscopist keeps the optics of his Microscope clean and free from fingerprints and dust.

Every installation should be provided with a camel's hair brush, syringe, and a well washed piece of linen. On account of its fine texture, a piece of linen that has been washed several times is the most desirable cleaning material. No dust should be permitted to settle upon the lenses, nor should fingers come into contact with any of the surfaces.

The Objectives and Eyepieces may be removed from the Microscope for cleaning, but they should never be disassembled, since it is almost impossible to re-establish their precision factory alignment.

To remove dust, try to blow it off with a syringe, or dust it off with a camel's hair brush. Avoid hard wiping, as dust is often hard and abrasive. To remove fingerprints, wipe

lightly with a clean soft cloth or absorbent cotton, lightly moistened with soap and water, alcohol, or as a last resort, Xylol. A small amount of absorbent cotton wound on the end of a tapered stick makes a handy cleaning tool for recessed optical surfaces. Avoid excessive use of solvents as this may cause run-ins in cemented optics, or the flowing solvent may pick up grease from the mounts, making cleaning a tedious job.

Clean immersion Objectives immediately after use by removing the fluid with lens paper or clean soft cloth.

Quality Lens Paper is available from most Scientific Supply Houses.

MECHANICAL MAINTENANCE

Should the exterior surfaces of the Microscope become dirty, it may be cleaned with a soft cloth moistened in Chlorothene. Avoid the use of excessive solvent which might run into bearings and dilute their lubricant.

Lubrication of the Microscope is rarely required, due to the use of ball-bearings and nylon bushings in all critical friction points. The Coarse and Fine Adjustment mechanism uses self-lubricated ball-bearings for both thrust and slide bearings.

Remove any immersion oil which may adhere to any part of the Stand with a cloth moistened with Chlorothene and wipe dry with a soft lintless cloth or chamois.

SAFETY CLUTCH ADJUSTMENT

The focusing motion safety clutch is set at the factory to provide an optimum balance of forces which will prevent the Stage from slipping downward under normal usage. An adjustment of this clutch setting is available if it is desirable to place a heavy object on the stage. The clutch adjustment nut is accessible by removing the cover in the back of the Arm, Fig. 16-1. Using a 5/16" socket nut driver, available at most hardware and radio supply houses, the adjustment nut can be engaged. A clockwise turn will tighten the clutch; counterclockwise rotation will loosen it. Always remember that too loose an adjustment will permit the Stage to drop out of focus upon the slightest shock or additional weight (possibly even of its own weight); too tight an adjustment will cause damage to specimen slides and Objectives if the Stage should inadvertently be focused too high.

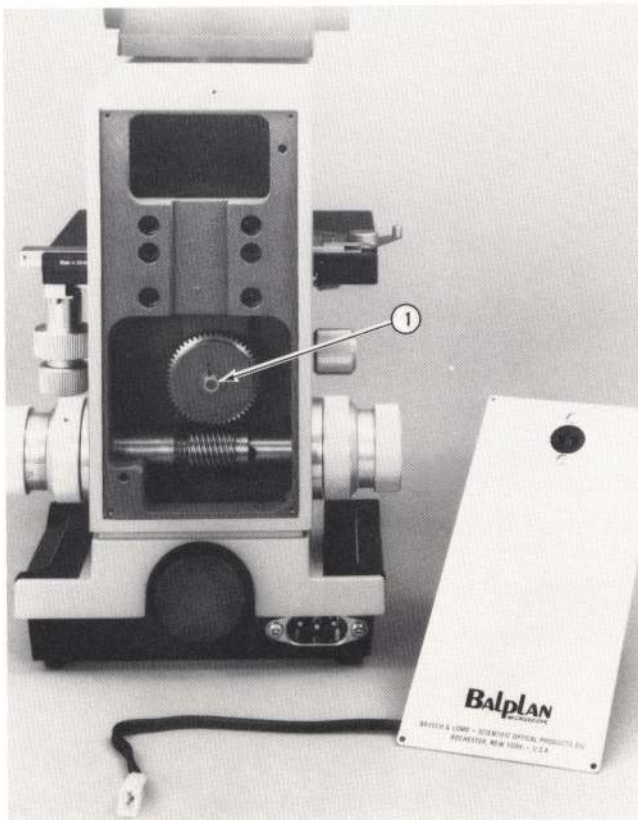

FIG. 16-1 - BALPLAN MICROSCOPE WITH BACK COVER REMOVED

1. Clutch Adjustment Nut

SECTION - 17 Carrying Case

A Carrying Case, Cat. No. 31-40-93, is available for the Balplan Microscope. This Case was designed for convenience of transportation and storage.

NOTE

It is not to be used as a Shipping Carton. The Carrying Case will accept any assembled combination of Heads (Double Head not included), Stages, Condensers, Nosepieces, Professional Optilume, or High Intensity Base Illuminator with the base and Arm.

If your Balplan is equipped with the 45° Binocular Head, it is necessary to remove the Eyepieces and store them in the accessory rack provided. If the Eyepiece Tubes of the 45° Binocular Head have been set substantially outward for acuity adjustment, it may be necessary to screw them in to avoid interference with the cover. Thin accessories (Bertrand Lens Attachment, Slide Attachment) may be left on the Microscope with the 30° Binocular Head if the Eyepieces are removed.

If your equipment includes the High Intensity Base Illuminator or the Professional Optilume, the line cord must be disconnected from the Base. It can be conveniently stored by wrapping around the arms provided in the cover of the Case. The Balplan fits into the Carrying Case as shown in Fig. 17-1.

An accessory rack is provided to accept two Eyepieces, bottle of Immersion Oil, Triocular Tube and four Filters (2"). A box of specimen Slides may be stored under the Accessory Rack. Provision has been made also for the storage of a Hemacytometer in its case, Fig. 17-2.

The Eye Guards should be removed from the Eyepieces and stored in the two holes provided in the foam pad on the case's cover.

Phase Contrast Accessories should be removed from the Microscope and stored in their own case.

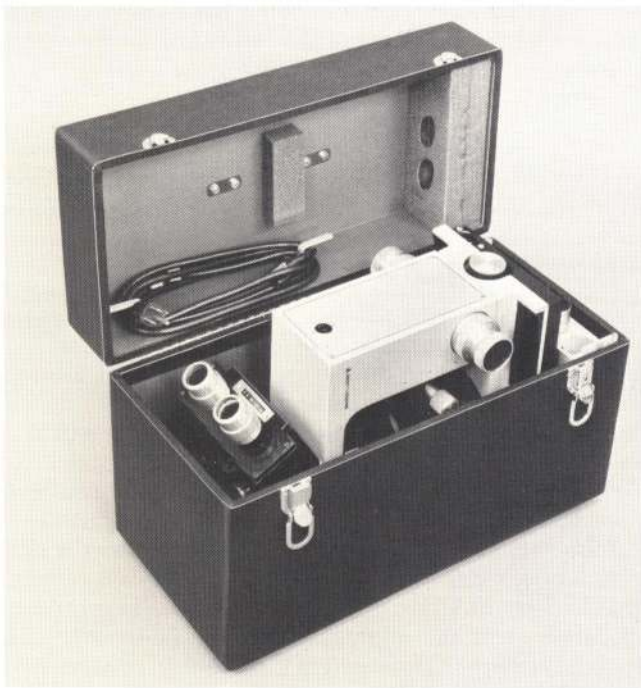

FIG. 17-1 - BALPLAN MICROSCOPE IN CARRYING CASE

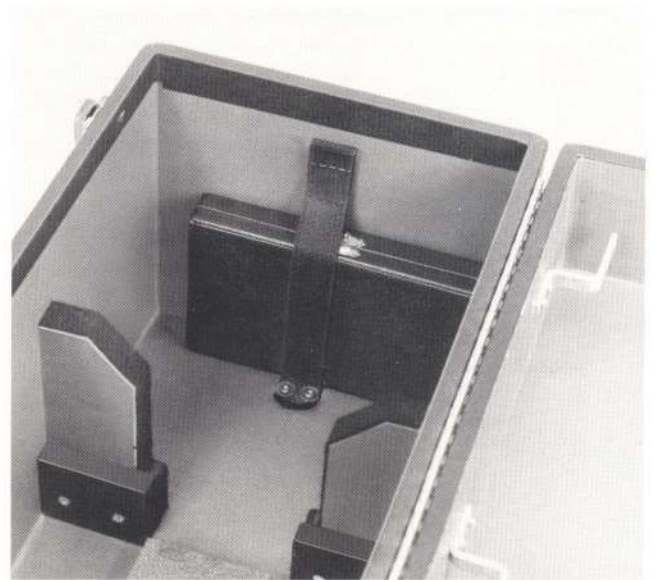

FIG. 17-2 - HEMACYTOMETER CASE

SECTION - 18

Accessories And Replacements

	STAND		OBJECTIVES
31-01-50	Stand	31-12-19	10X - LWD 0.25 N.A. Planachromat
31-01-51	Plain Base	31-12-20	2.5X - 0.0625 N.A. Planachromat
31-01-51-106	Base Plug	31-12-21	4X - 0.09 N.A. Planachromat
31-01-53	Bottom Cover	31-12-22	10X - 0.25 N.A. Planachromat
31-01-54	Arm Plug	31-12-23	20X - 0.50 N.A. Planachromat
	ILLUMINATORS	31-12-24	40X - 0.65 N.A. Planachromat
31-32-15	Professional Optilume, 120V	31-12-26	100X - 1.25 N.A. Planachromat
31-32-16	High Intensity Base Illuminator, 120V	31-51-71	Funnel Stop for 31-12-26
31-32-05	Professional Optilume (Canadian)	31-12-88	50X 0.80 N.A. Planachromat (oil)
31-32-06	H1B1 (Canadian)		
31-32-37	Professional Optilume (240V)		
31-32-38	H1B1 (240V)	31-18-14	HEADS
		31-18-77	Photobinocular Head
		31-18-79	Binocular Head
		31-18-81	Trioocular Head
		31-18-83	Focusable Trio Tube
31-60-12	Plain Stage with Rack and Pinion Substage	31-18-84	Dual Viewing Adapter w/o Pointer Projector
31-60-45	Integral Graduated Mechanical Stage with Rack and Pinion Substage, Left Hand	31-18-85	Multiple Viewing Adapter w/o Pointer Projector
31-60-44	Integral Ungraduated Mechanical Stage with Rack and Pinion Substage, Left Hand	31-18-91	Multiple Viewing Adapter with Pointer
31-60-43	Integral Graduated Mechanical Stage with Rack and Pinion Substage, Right Hand	31-18-93	45° Binocular Head
31-60-42	Integral Ungraduated Mechanical Stage with Rack and Pinion Substage, Right Hand	31-18-96	Dual Viewing Adapter with Pointer
31-60-46	Stage Finger Ass'y. (L.H.)	31-18-97	Multiple Viewing Adapter CSA
31-60-47	Stage Finger Ass'y. (R.H.)		Dual Viewing Adapter CSA
		31-15-61	EYEPIECES
		31-15-62	10X Wide Field
		31-15-67	15X Wide Field
		31-50-20	10X Wide Field with focusable lens
			Eye Guard for 31-15-61
	CONDENSERS		
31-55-13	1.25 N.A. Aplanatic Condenser		POLARIZING ACCESSORIES
31-55-14	Flip-In Lens	31-55-77	Polarizer
31-55-15	1.25 N.A. Flip-Out Condenser	31-57-84	Eye Cap with Analyzer
31-55-33	Paraboloid Condenser - Dark Field	31-57-86	Analyzer Slide for use in Slide Attachment
	NOSEPIECES		
31-18-68	Five-Hole Nosepiece	31-57-92	Slide Attachment
31-18-71	Nosepiece Adapter		

SECTION 18. ACCESSORIES AND REPLACEMENTS

FILTERS			
31-34-30	Neutral Filter, 0.3 Density, 2" Square	31-12-43	100X - 1.25 N.A. Phase Planachromat Objective
31-34-31	Neutral Filter, 0.6 Density, 2" Square	31-55-31	Turret Phase Condenser
31-34-32	Neutral Filter, 1.2 Density, 2" Square	31-55-32	LWD Phase Condenser
31-34-35	Neutral Filter 0.9 Density, 2" Square	31-58-63	10X Phase Stop for LWD
31-34-71	Light Blue Daylight 2" dia. thin	31-58-64	20X Phase Stop for LWD
31-34-73	Neutral Filter, 0.7 Density, 2" dia.	31-58-65	40X Phase Stop for LWD
31-34-75	Neutral Filter, 1.3 Density, 2" dia.	31-58-66	100X Phase Stop for LWD
31-35-86	Color Balancing Daylight Film, 2" dia.	31-50-78	Auxiliary Telescope for Phase Contrast
31-35-87	Color Balancing Tungsten Film, 2" dia.	31-35-61	Green Filter for Phase Contrast, 2" dia.
31-35-91	Color Balancing Polacolor II Film, 2" dia.	31-40-84	Phase Case
31-35-93	Yellow, 2" dia.	31-57-85	Bertrand Lens
		31-55-24	Flip-In Lens (to fill field of 4X B.F. Objective when using 31-55-31 Condenser)
RETICLES			
31-16-50	Filar Eyepiece, 12.5X		
31-16-69	Micrometer Disc - .001" divisions	31-31-81-01	
31-16-71	Whipple Disc		
31-16-72	Howard Disc	31-31-50	Replacement Lamp for 31-18-85 and 31-18-93 Pointers
31-16-73	Milk Smear Disc		
31-16-76	Porton Reticle		
31-16-89	Stage Micrometer, Ruled to 0.001 inches		
31-16-90	Stage Micrometer, 0.1mm to 0.01mm	31-32-93	
PHASE CONTRAST ACCESSORIES			
31-12-40	10X - 0.25 N.A. Phase Planachromat Objective	31-49-57	Wire Harness
31-12-41	20X - 0.50 N.A. Phase Planachromat Objective	31-49-62	Dust Cover for Conference Models
31-12-42	40X - 0.65 N.A. Phase Planachromat Objective	31-49-63	Dust Cover for Dual Viewing Models
		31-50-98	Dust Cover for Biological Models
		31-40-93	Immersion Oil - Low Viscosity
		310150-191	Carrying Case for Balplan Microscope
			#6 Hex Wrench, Short Arm

LAMPS

Replacement Lamp for 31-32-15, 31-32-16, 31-32-37 and 31-32-38 T-H Illuminators

Replacement Lamp for 31-18-85 and 31-18-93 Pointers

MISCELLANEOUS

Wire Harness

Dust Cover for Conference Models

Dust Cover for Dual Viewing Models

Dust Cover for Biological Models

Immersion Oil - Low Viscosity

Carrying Case for Balplan Microscope

#6 Hex Wrench, Short Arm



BAUSCH & LOMB 

Together...we'll create tomorrow.

INSTRUMENTS & SYSTEMS DIVISION

42 East Avenue, P.O. Box 743, Rochester, New York 14603

310150-350

Printed in U.S.A.